



# **NURSE CALL** and **HEALTHCARE BED** **ACCESSORIES**





### OUR LONG HISTORY

Curbell has been supplying hospitals and long-term care facilities with innovative products for over 50 years. We have strong relationships with bed, television, and nurse call system manufacturers, and we work closely with them to ensure that our products work properly and safely with all types of equipment. Most importantly, we work with you, to create custom solutions that meet your requirements and specifications.

### NURSE CALL EXPERIENCE

From our beginning, Curbell has been involved in connecting hospital room equipment to various types of nurse call systems. Since then, we've become an industry leader in nurse call system integration, and we use this expertise to make sure that our equipment properly interfaces with your nurse call system, no matter what brand it is.

### OUR COMMITMENT TO QUALITY

Curbell works to continuously improve our operations, products, and services. Our quality management system complies with ISO 13485:2003 (CMDCAS), and we are compliant with all government and industry regulations. We are also medical device listed, and are a current Good Manufacturing Practices (cGMP) Compliant Facility.

# CONTENTS

- Quality and Oxygen Safety . . . . . **2**
- Nurse Call Devices . . . . . **3**
- Gen4 Pillow Speakers . . . . . **4-7**
- Gen4 Pillow Speaker Accessories . . . . . **8**
- Customized Solutions . . . . . **9**
- Gen4 Interactive and Smart TV Pillow Speakers . . . . . **10-11**
- Gen III Pillow Speakers and Handheld Pendants . . . . . **12**
- Pillow Speaker Testers . . . . . **13**
- Remote Entertainment Station . . . . . **14-15**
- Pillow Speaker Repair Service . . . . . **16**
- Call Cord Solutions . . . . . **17-20**
- Specialty Call Cords . . . . . **21-24**
- Adaptors . . . . . **25-27**
- Wall Plates . . . . . **28**
- TV Jumper Cables . . . . . **29**
- Dummy Plugs . . . . . **30**
- Bed Communication Cables . . . . . **31-32**
- Bed Breakaway Cables . . . . . **33-35**
- Bed-to-Nurse Call Cables . . . . . **36-37**
- Breakaway Cable Locking Solutions . . . . . **38-39**
- Standard Bed Communication Cables . . . . . **40**
- Standard Bed-to-Nurse Call Cables . . . . . **41**
- Receptacle Kits and 37-Pin Dummy Plugs . . . . . **42**
- Low Voltage Controllers . . . . . **43-46**
- Parts and Price Listings for Individual Nurse Call Systems . . . . . **47-79**
- Other Product Lines . . . . . **80**
- Ordering and Warranty Information . . . . . **Back Inside Cover**

Curbell is a registered trademark and service mark of Curbell Inc.  
 All other trademarks and service marks are property of the respective manufacturers as noted by the appropriate trademark notice throughout this catalog.  
 Prices are subject to change without notice.



## QUALITY AND OXYGEN SAFETY

### KEEPING YOUR PATIENTS SAFE

The healthcare industry has important regulations associated with UL compliance and oxygen safety that impact nurse call accessories (visit [www.oxygensafe.com](http://www.oxygensafe.com) for more information). The nurse call accessories manufactured by Curbell continue to meet not only oxygen safety standards, but all other applicable compliance standards. Nearly all of Curbell's nurse call accessories are UL Listed and all are tested directly with the intended nurse call systems and healthcare televisions to ensure the highest level of safety and regulatory compliance.

- ▶ All our pillow speakers are medical device listed
- ▶ We are a UL testing facility
- ▶ We are certified to ISO 13485:2003 (CMDCAS)

## NURSE CALL DEVICES

### KEEPING YOU CONNECTED

Hospital patient rooms depend on connectivity, between patients and nurses, and the various technologies that impact the patient experience; and Curbell Medical is a crucial part of the ever-evolving interface that makes all of these connections possible.

By combining our deep institutional knowledge and decades of experience, we create innovative solutions that make hospitals more efficient, and improve patient comfort and safety. It's instant peace of mind, and it's as easy as pressing a button.



# MORE HOSPITALS CHOOSE GEN4 THAN ANY OTHER PILLOW SPEAKER. HERE'S WHY:



## PATIENT SATISFACTION

These days, patients expect more than just quality care. They expect many of the comforts of home in a peaceful environment, and your patient satisfaction surveys will reflect this. Gen4 gives them a quality TV experience that will help keep them satisfied, with its large, easy-to-press buttons, clear sound, and comfortable shape.

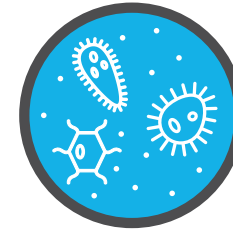

## INFECTION CONTROL

A single hospital-acquired infection can cost your facility tens of thousands of dollars<sup>1</sup>, so we made sure that Gen4 was fully sealed\* to help prevent infectious contaminants from getting into the pillow speaker where they could be passed from patient to patient. In addition, Gen4's smooth shape allows for quick and easy cleaning.



## SOUND OPTIONS

87% of hospitals recognize that they have a noise problem<sup>2</sup>. If yours is one of them, you can minimize noise by using headphones and a Gen4 pillow speaker with an optional headphone jack. Patients will be more satisfied with their TV experience without being distracted by noise, and nearby patients and staff will benefit from a quieter environment.



## PATIENT SATISFACTION THE LITTLE THINGS ADD UP

When they're in your hospital, your patients' main concern is their health. But if you ask them how satisfied they were with their stay, they're likely to mention the things that can affect your HCAHPS scores, like the noise level, the cleanliness of the room, and their experience with the television. Good experiences with all these little things can lead to a positive overall experience, and maybe even higher patient satisfaction scores for your hospital.

These are the things we thought about when we designed Gen4. We included key design features that will help you in your efforts to reduce noise, control infection, and offer a better overall patient room experience. On their own, little things like these might not mean much; but together, they add up to one more thing to be satisfied about.



## EASE OF USE AND DURABILITY

Gen4 isn't just easy for patients to use, it's easy for your staff. We have 50 years of experience integrating nurse call systems and TVs, so installation and reprogramming for new TVs is simple. It's also built to last, with high-impact case material and a flexible cable. But hospitals are a tough environment, which is why we give you the option to easily replace the cable, speaker, headphone jack, and overlay in the field if they get damaged.

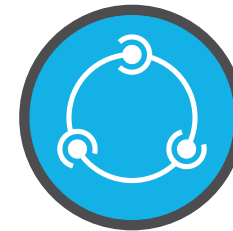

## PATIENT ROOM INTEGRATION

The pillow speaker is at the center of the patient room experience, giving patients access to their care team, entertainment, and environmental controls, so we work closely with the manufacturers of these systems to make sure everything works together seamlessly. This is part of the reason why Curbell is trusted by every nurse call system manufacturer in the US to supply the pillow speakers for their systems.

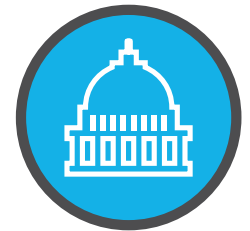

## REGULATORY COMPLIANCE

In the US, pillow speakers are classified as Class 2 Exempt medical devices. Curbell is fully compliant with all government registrations and industry regulations. Gen4 is designed, manufactured, and tested to strict standards (including UL 1069) to give your patients a reliable connection, and to give you one less thing to worry about.

1. [http://www.cdc.gov/HAI/pdfs/hai/Scott\\_CostPaper.pdf](http://www.cdc.gov/HAI/pdfs/hai/Scott_CostPaper.pdf) 2. [www.theberylinstitute.org/resource/resmgr/webinar\\_pdf/final\\_-\\_noise\\_webinar.pdf](http://www.theberylinstitute.org/resource/resmgr/webinar_pdf/final_-_noise_webinar.pdf)  
\* units without a headphone or keyboard jack have an Ingress Protection Rating of IP54 as defined by IEC 60529

# THE GEN4 PILLOW SPEAKER

**FULLY SEALED UNIT**  
The sealed design reduces the potential risk of infectious fluids or solids settling into the unit — even in the speaker area.

**DURABILITY**  
The high-impact case material is designed to withstand over 100 drops onto a concrete floor without impacting its functionality.

**AUXILIARY FUNCTIONS**  
The Gen4 platform allows for up to six auxiliary buttons to control lighting, temperature, drapes, nurse call requests, etc.

**LARGE BUTTONS**  
Large buttons are recognizable at a glance and easy to press. The clean layout makes contacting the Nurse and controlling TV functions simple.

**SUPERIOR SOUND**  
Clear, high quality sound to increase patient satisfaction.

**COMFORT-GRIP CASE**  
The lightweight ergonomic design mimics the comfort and familiarity of a home TV remote.

**EASY-TO-CLEAN CASE**  
The streamlined design facilitates quick and easy cleaning with most hospital cleaning agents.

**REPAIRABILITY**  
You can utilize Curbell's repair service or choose to make basic repairs yourself, including quick cable replacement.

**FLEX AND STRAIN RELIEF**  
The long flex relief was designed for longer life and greater flexibility. Internal strain relief prevents damage to internal components.

**CHOOSE FROM TWO STYLES**  
**DirectAccess** (our most popular format, pictured above): the user can directly access individual channels through the numeric keypad  
**DPS**: the user cycles through channels using the large channel up and down buttons



## ADDITIONAL GEN4 FEATURES



**OPTIONAL HEADPHONE JACK**  
Plug in 1/8" plug earphones to create a quieter environment. Your patients will appreciate the ability to hear the TV better, and everyone else will appreciate the peace and quiet.



**ANALOG VOLUME CONTROL**  
Analog volume is available to ensure independent patient control in situations where two devices (any combination of pillow speakers, beds, or Curbell Remote Entertainment Stations (see page 14) control one TV.



**REPAIRABILITY**  
Gen4 is built to last; but hospitals are a tough environment, which is why we give you the option to easily replace the cable, speaker, headphone jack, and overlay in the field if needed.

# GEN4 PILLOW SPEAKER ACCESSORIES

## SINGLE-USE HEADPHONES AND EAR BUDS

- Help lower noise levels
- Lightweight and comfortable

DESCRIPTION	MODEL #	PART #	PRICE
Black stereo headphones	HP-030	7584	\$2.75
Black mono headphones	HP-050	7585	\$2.75
Black mono ear buds	HP-200	7586	\$1.75

**NOTE:** Cases of 100 available. Contact your sales representative for pricing.



## BREAKAWAY CONNECTION

Save time and money, and minimize plug and station damage from everyday wear with the pillow speaker breakaway solution from Curbell. The "pinless" cable plug fits into a mating cable that is secured to a dedicated wall receptacle. It provides a reliable connection that releases with a determined amount of force, taking the strain off the wall connection.

- Reduces damage to pillow speaker plug end
- Eliminates damage to nurse call patient stations
- Provides a means to standardize pillow speakers in your facility

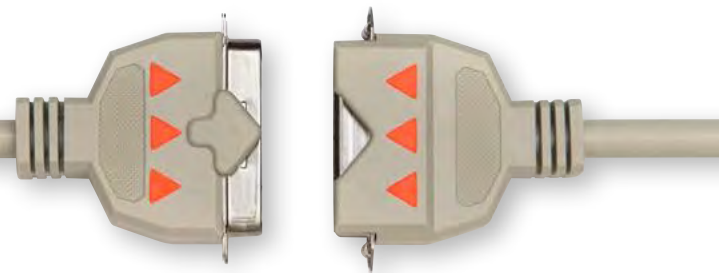

## PILLOW SPEAKER HOLDER

The optional Pillow Speaker Holder mounts to the wall or headwall and keeps Gen4 Pillow Speakers secure.

DESCRIPTION	MODEL NUMBER	PART NUMBER	PRICE
Gen4 Pillow Speaker Holder	MSC-4023-001	9598	\$8.95

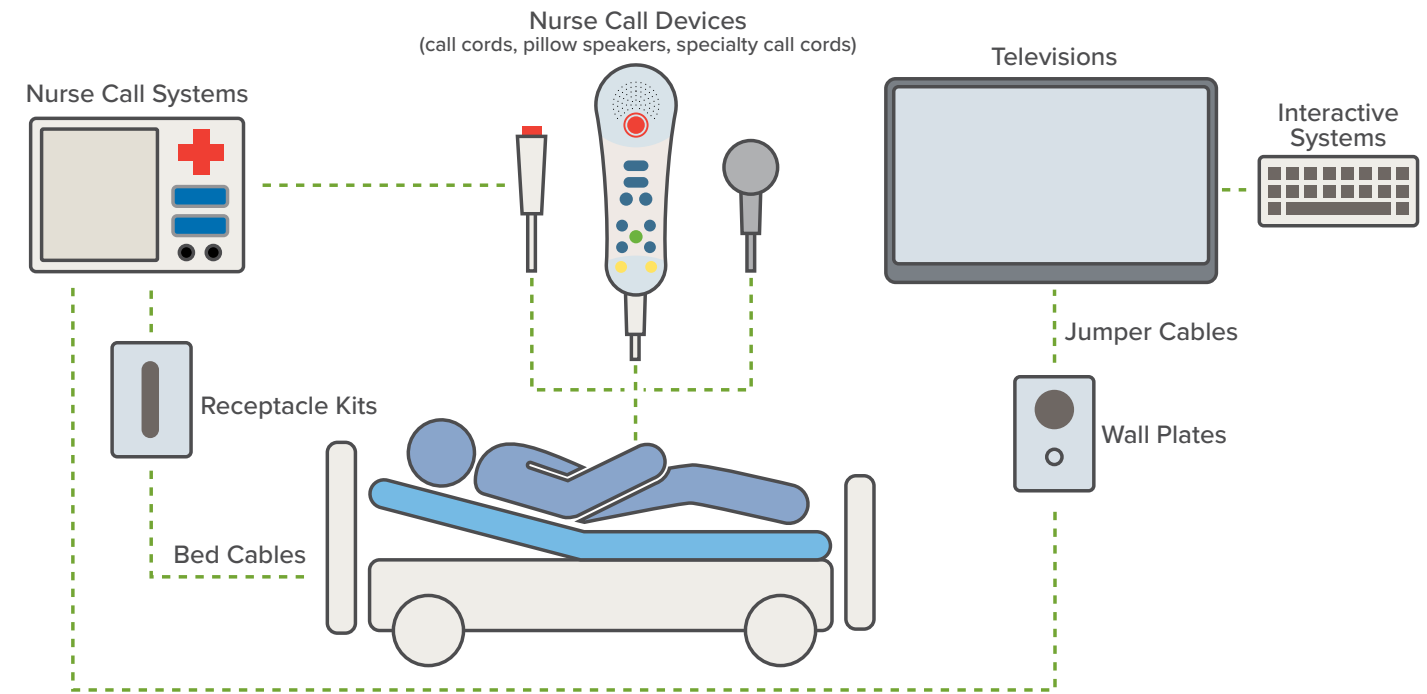

## CUSTOMIZED SOLUTIONS WE'RE HERE TO HELP

Among the dozens of nurse call systems, televisions, interactive systems, and beds available, there are tens of thousands of configurations possible in any hospital room. Once you add in lighting options, wiring inconsistencies, and additional special features, it's easy to see that designing and specifying the products that enable communication between these systems requires a lot of expertise.

Curbell Medical works closely with all the manufacturers of these systems to make sure that our products operate properly, and our knowledgeable staff can quickly help you select the right products to meet your specific requirements. You can count on Curbell to keep you connected.

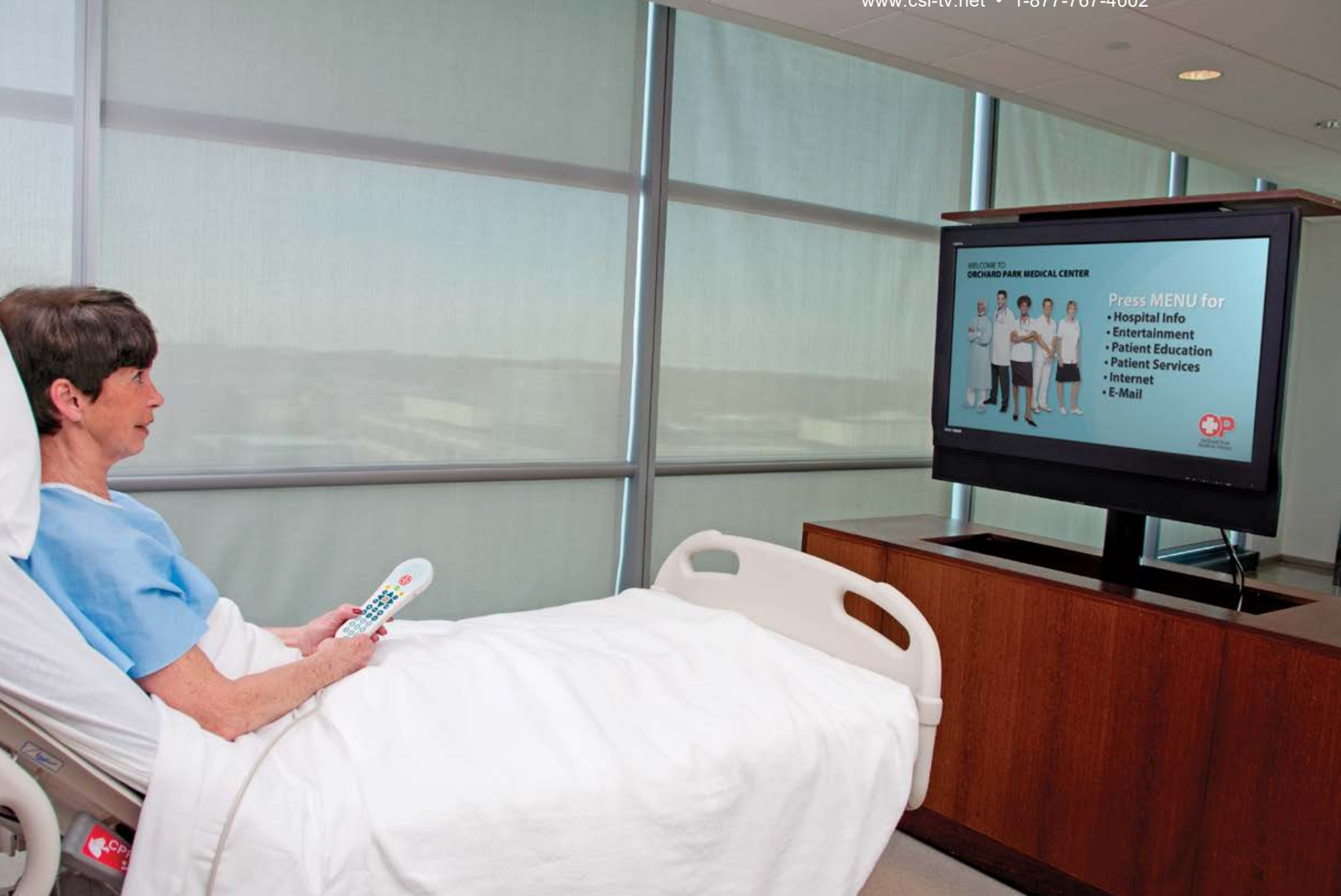

# GEN4 FOR INTERACTIVE AND SMART TV

## HELPING KEEP YOUR PATIENTS ENGAGED

Curbell works with patient engagement system and Smart TV manufacturers to create Gen4 Pillow Speakers that are designed specifically for each system. Each pillow speaker gives you most features of our standard Gen4 Pillow Speaker, plus the ability to access and navigate through features specific to the patient engagement system or smart TV, like on-screen menus and guides. Contact Curbell or your patient engagement system manufacturer for more information.

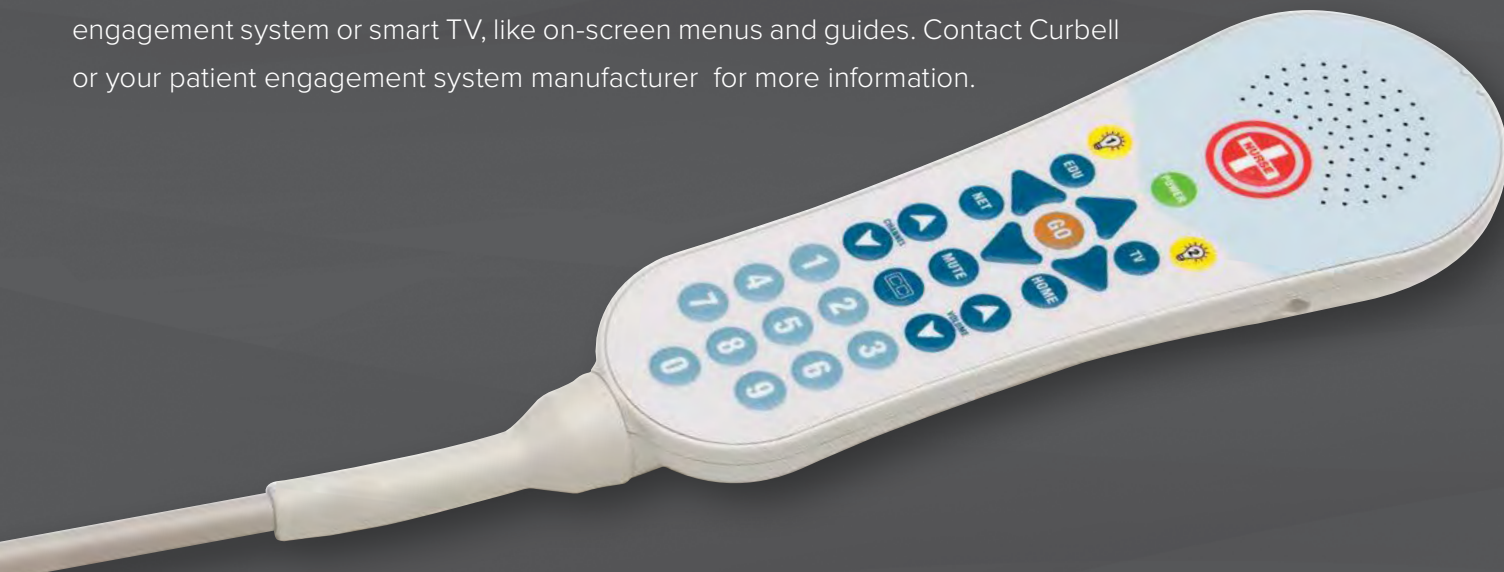

The units shown here represent a small sample of the interactive and Smart TV pillow speakers available from Curbell.

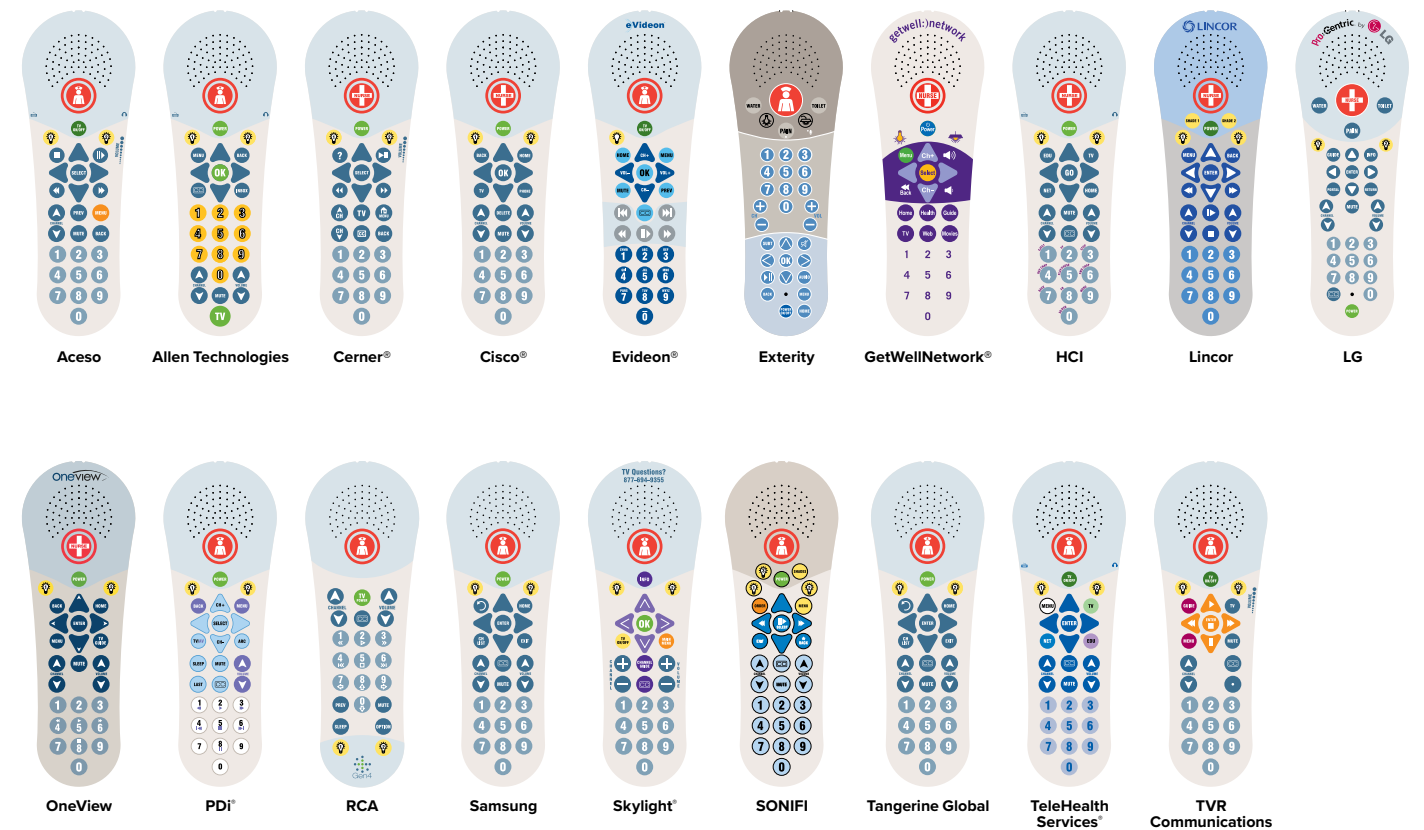

## DIGITAL INTERFACE BOX (IBI)

Pillow speakers no longer communicate only with standard televisions. Today's technology presents ever-increasing demands for various additional integrations. The Curbell IBI has many potential applications, including the facilitation of an interface between pillow speakers and USB- or IP-driven hardware. The box is FCC-compliant and carries a UL Listing to hospital standards. Please contact Curbell with your customized application needs.

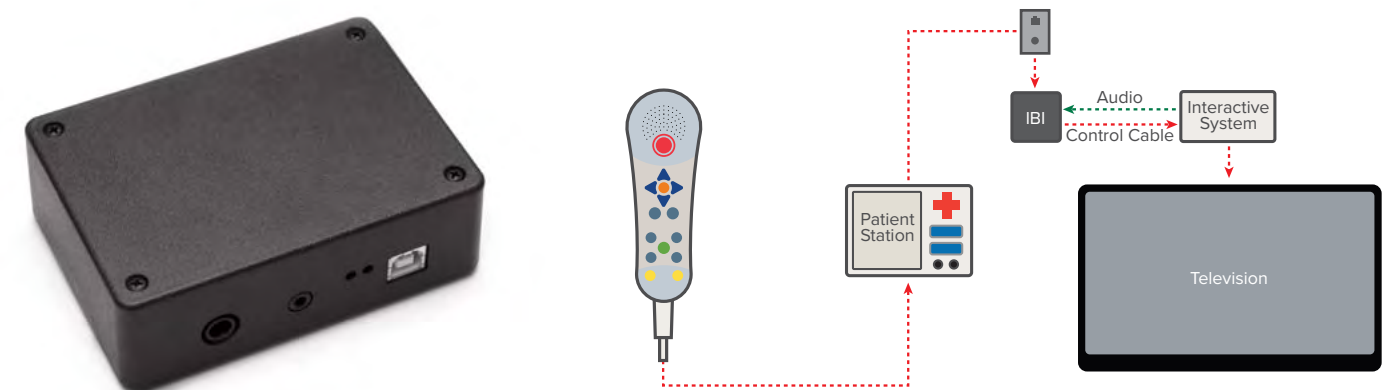

# ANALOG SOLUTIONS



## GEN III ANALOG PILLOW SPEAKERS

These are our simplest pillow speaker offering, designed to support older, analog TV technology, basic nurse call functionality, and environmental control.

- Single button TV channel navigation
- Up to four environmental control buttons
- Safe for use in oxygen-enriched environments



## HANDHELD PENDANT

Curbell's handheld nurse call pendants are perfect for areas where a speaker isn't necessary, such as areas with swing-arm televisions, or emergency rooms and intensive care units that don't have televisions.

- Large, colorful buttons are easy for patients to operate
- Overlay and switches can be tailored to your hospital's needs
- Can support up to four auxiliary functions
- Safe for use in oxygen environments
- Electrostatic Discharge (ESD) resistant design
- Self-extinguishing case material
- Repairable

## SEALED HANDHELD PENDANT

The Gen4 Sealed Handheld Pendant brings the nurse call pendant into the 21st century, with its comfortable design, and industry-leading infection control and safety features.

- Proprietary sealed design (to IP67) keeps infectious contaminants out of the pendant
- Smooth shape and minimal crevices allow for easy, comprehensive cleaning, and reduce the potential for cross-contamination
- Modern, comfortable, ergonomic design fits naturally in the hand
- Large Nurse button is easy for patients to locate and operate
- Call assurance LEDs available for supporting systems
- Customizable auxiliary buttons
- UL Listing involves testing with the nurse call system to verify for safe use in an oxygen-enriched atmosphere

# PILLOW SPEAKER TESTERS

## CT-5 FOR RAULAND RESPONDER® 5 PILLOW SPEAKERS

The Curbell CT-5 tester is a portable unit designed to test any Curbell-manufactured pillow speakers compatible with the Rauland Responder 5 nurse call system. The CT-5 tester is to be used in conjunction with the included USB cable and a user-supplied desktop or laptop PC. It can test all Rauland Responder 5 Standard and Enhanced pillow speakers, as well as Curbell-manufactured "interactive" models compatible with the Rauland Responder 5.

Once connected to the tester and properly configured with a PC, you will be able to test the functionality of nurse call, nurse call workflow, environmental control auxiliaries, entertainment, call assurance, as well as speaker and microphone features.

- Quickly confirms functionality of buttons, LEDs, speaker and microphone
- Powered by the USB connection on the computer (no batteries or wall connection required)
- Automatic recognition of pillow speaker type
- Colorful graphical user interface indicates the unit being tested
- Visual and audio confirmation of working buttons
- Hardware and software included
- Designed for use with a computer running Windows XP, 7, or 8



The included software shows which pillow speaker functions are being tested

## CT-300

The Curbell CT-300 Tester is a portable unit that allows you to test pillow speakers, call cords, Stryker® bed side rails, and Hill-Rom® analog SideCom™ bed side rails. The CT-300 interfaces to virtually any Curbell pillow speaker through interchangeable modules, and will test nurse call on all pillow speaker models and TV entertainment and auxiliary functions on most pillow speakers.

- Small, compact, and portable
- LCD display screen prompts for easy use
- Battery operated, AC adaptor included
- Order multiple adaptors for testing all equipment





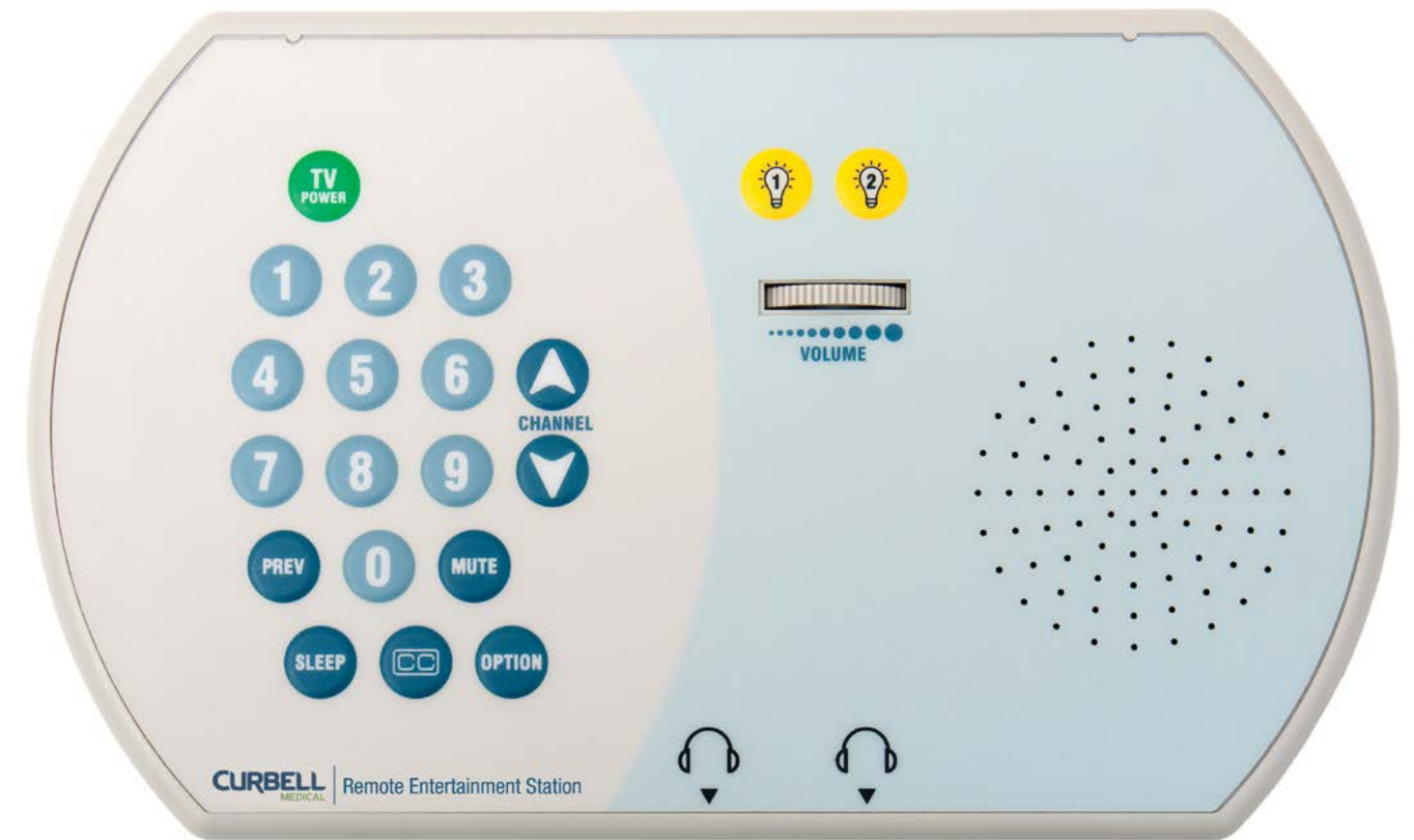

The Remote Entertainment Station provides easy access to the same TV features as a pillow speaker.



Visitors can watch television in the hospital room without disturbing the patient.



In waiting rooms, audio is brought to the seating area, helping to create a quieter atmosphere.

# THE REMOTE ENTERTAINMENT STATION

## MAKE A PATIENT ROOM A FAMILY ROOM

Curbell's Remote Entertainment Station provides convenient wall-mounted control of a healthcare grade television, and up to four low-voltage room auxiliaries for visitor use. It allows supplemental television access without disturbing the patient, preserving a quiet atmosphere. It can also be used in waiting and lobby areas to eliminate the need for remote controls.

- Creates a visitor-friendly, home-like environment
- The Remote Entertainment Station is easily reprogrammed for any healthcare grade television
- Allows control of up to four room auxiliaries such as lighting, temperature, and drapes
- Two headphone jacks are ideal for creating a quieter environment
- Easy to install and repair
- Two year warranty

SPECIFICATIONS	
Case	High impact plastic (ABS), UL flammability rating 94V-0
Dimensions	8.5" W x 5" H x 1.25" D
Mounting	Mounts to a two gang masonry box
Switches	SPDT momentary contacts for connection to power-limited circuits of 30V DC, 500 mA or less
Wiring	Cable harness included

# PILLOW SPEAKER REPAIR SERVICE



Curbell's highly trained repair team has the expertise to troubleshoot equipment malfunctions, provide timely repair, and keep your patient rooms connected. Save time and money by sending Curbell your damaged or malfunctioning pillow speakers. If you'd like to repair your pillow speakers yourself, see page 79 for parts and prices.

- Quick turnaround
- Repair available for most brands and models
- 90-day limited warranty against defects in materials and workmanship



**1** Call Curbell for an RMA number, then ship the product to us.

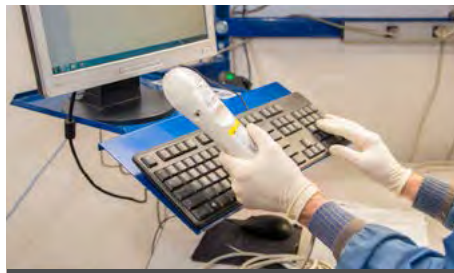

**2** The product is received in and routed to the correct repair station.



**3** The product is cleaned inside and out.



**4** The product is refurbished to original specifications.



**5** The product is 100% tested.



**6** The product is shipped back to you with a new 90 day warranty.



## CALL CORDS A SIMPLE SOLUTION

Call cords may be the simplest type of nurse call device, but they're often the best choice for areas without TVs, or for situations where a patient has special needs. Curbell's wide range of standard and specialty call cord options lets you handle any situation.

# CHOOSING A CALL CORD



## Which type of call cord is right for you?

Curbell offers seven types of call cords to meet the needs of your facility and your patients. You can learn more about those options on the next six pages. If you need more help determining what solution is right for you and your situation, call your Curbell sales representative at 1-800-235-7500.

	 Gen4 Sealed Call Cord (page 19)	 Classic Call Cord (page 20)	 Breathcall® (page 22)	 E-Z Call™ (page 22)	 Mechanical Pad (page 23)	 Padcall® (page 24)	 Presscall® (page 24)
You need a simple nurse call device	●	●	●	●	●	●	●
You need the device to be oxygen Safe	●	●	●	●	●	●	●
Easy cleaning	●				●		
The patient has limited dexterity			●	●	●	●	●
The patient has limited mobility			●	●			
The device needs to control Nurse Call and TV			●				●
You would like an air-activated switch			●			●	●
Your nurse call system requires a normally closed switch		●	●	●		●	●

# GEN4 SEALED CALL CORDS



The Gen4 Sealed Call Cord brings the call cord into the 21st century, with its comfortable design, and industry-leading infection control and safety features.

## INFECTION CONTROL











- Proprietary sealed design keeps infectious contaminants out of the pendant
- Smooth shape and minimal crevices allow for easy, comprehensive cleaning, and reduce the potential for cross-contamination

## PATIENT SATISFACTION

- Modern, comfortable, ergonomic design fits naturally in the hand
- Large button is easy for patients to locate and operate
- Call assurance LEDs available for supporting systems

## OXYGEN SAFETY

- UL Listing involves testing with the nurse call system to verify for safe use in an oxygen-enriched atmosphere (visit [www.oxygensafe.com](http://www.oxygensafe.com) for more information)

	PLUG TYPE	NURSE CALL SYSTEM	DESCRIPTION	MODEL NUMBER	PART NUMBER	PRICE
	1/4"	Universal	8 ft.	SCC-0101-080-N	13259	\$16.95
	1/4"	Universal	12 ft.	SCC-0101-120-N	13261	\$18.95
	18-pin	Ascom/GE, Dukane	8 ft.	SCC-3701-820-U	13281	\$42.95
	8-pin DIN	Jeron Provider 680	8 ft.	SCC-1901-081-U	13268	\$26.95
	8-pin DIN	Jeron Provider 680+	10 ft.	SCC-4201-101-U	13286	\$29.95
	8-pin DIN	Rauland Responder 4	8 ft.	SCC-1901-080-U	13266	\$26.95
	9-pin DIN	Rauland Responder 5	10 ft.	SCC-4101-100-N	13285	\$33.95
	8-pin DIN	Tektone Tek-CARE 400	8 ft.	SCC-1901-082-N	13269	\$26.95
	15-pin	SimplexGrinnell EZCare	8 ft.	SCC-2908	13277	\$46.95
	8-pin Modular	Critical Alert, Intego, TekTone, Wescom, West-Com	8 ft.	SCC-2101-080-U	13273	\$21.95
	10-pin Modular	West-Com	8 ft.	SCC-2402-080U	13276	\$24.95

# CLASSIC CALL CORDS

Our Classic Call Cords are designed to meet your facility's wiring requirements, and are safe for use in oxygen-enriched environments.

- Large contoured button is easy for patients to operate
- Button provides tactile feedback with an audible click
- Custom cable lengths available
- Switch rated for minimum of 30,000 cycles per UL 1069 section 24
- Electrostatic Discharge (ESD) resistant design
- Self-extinguishing material



PLUG TYPE	NURSE CALL SYSTEM	DESCRIPTION	MODEL NUMBER	PART NUMBER	PRICE
1/4"	Universal	12 ft.	CC144-010	5733	\$16.95
1/4"	Universal	12 ft., dual	CC144-090	5740	\$36.95
1/4"	Universal	16 ft., coiled	CC192-030	5779	\$31.95
1/4"	Universal	8 ft.	CC96-010	5822	\$14.95
1/4"	Universal	8 ft., coiled	CC96-210	5847	\$23.95
1/4"	Universal	8 ft., dual	CC96-180	5843	\$32.95
1/4"	Universal	8 ft., inline	CC96-045	5829	\$14.95
1/4"	Universal	8 ft., normally closed	CC96-020	5823	\$14.95
18-pin	Ascom/GE Telligence, Dukane	12 ft.	CC144-112	5742	\$44.95
8-pin DIN	Intercall	8 ft.	CC96-200	5845	\$24.95
8-pin DIN	Jeron Provider 680	8 ft.	CC96-300	5851	\$24.95
8-pin DIN	Jeron Provider 620	8 ft.	CC96-315	5852	\$25.95
8-pin DIN	Rauland	8 ft.	CC96-750	5860	\$24.95
15-pin	SimplexGrinnell EZCare	8 ft.	CC96-983	5874	\$46.95
8-pin DIN	Tektone Tek-Care 400	8 ft.	CC96-970	5871	\$24.95
8-pin Modular	Critical Alert, West-Com, Intego	8 ft.	CC96-080	5835	\$19.95
9-pin	Zettler Sentinel 400	8 ft.	CC96-347	5854	\$30.95
9-pin	Zettler Sentinel 500	8 ft., normally closed	CC96-740	5859	\$30.95
6-pin	Zettler Zetcom	8 ft.	CC96-050	5830	\$32.95



## SPECIALTY CALL CORDS

EASE OF USE FOR THOSE WITH SPECIAL NEEDS

Our specialty call cords have ultra-sensitive touch surfaces that are ideal for patients with limited manual dexterity, and they can be used with most nurse call systems.

# SPECIALTY CALL CORDS

## BREATHCALL®

- Pneumatic device activated by the patient's breath
- Single and dual models available
- For patients with special needs (severe burns, paraplegics, quadriplegics, immobilized patients)
- Adjustable clamp fits side rail or headboard
- Arm can be adjusted to almost any position
- Additional straws and filters available



GEB-200



PLUG TYPE	NURSE CALL SYSTEM	DESCRIPTION	MODEL NUMBER	PART NUMBER	PRICE
1/4" plug	Universal	9'	GEB-010	7380	\$136.95
8-pin DIN	Rauland	9'	GEB-150	7387	\$165.95
9-pin	Zettler Sentinel 500	9', normally closed	GEB-195	7394	\$169.95
two 1/4" plugs	Universal	9', Dual (TV, Nurse)	GEB-200	7395	\$209.95
NA	NA	12 Straws/Gray Filters	GEB-290	7396	\$43.95

BreathCall devices are available for many other systems. Call your Curbell representative for more information.

## E-Z CALL™

- Can be placed anywhere for activation including the cheek, foot, hand, etc.
- Large tented design makes it easy for patient to see
- Linen clip securely attaches to bedding
- Velcro strip included for side rail mounting



PLUG TYPE	NURSE CALL SYSTEM	DESCRIPTION	MODEL NUMBER	PART NUMBER	PRICE
1/4" plug	Universal	10'	GEE-010	7402	\$64.95
1/4" plug	Universal	10', normally closed	GEE-090	7403	\$64.95



## MECHANICAL PAD

- Perfect for patients who may have difficulty using standard call cords or pillow speakers
- Large sensitive surface area
- Activates from any point on the pad's surface
- Linen clip securely attaches to bedding



PLUG TYPE	NURSE CALL SYSTEM	DESCRIPTION	MODEL NUMBER	PART NUMBER	PRICE
1/4" plug	Universal	10'	GEM-0000-AGY	7407	\$43.95
15-pin	SimplexGrinnell EZCare	10'	GEM-478	7434	\$49.95
18-pin	Ascom/GE, Dukane	10'	GEM-477	7433	\$48.95
20-pin	Cornell, Sylvania	10'	GEM-472	7431	\$48.95
37-pin	Universal	10'	GEM-150	7420	\$57.95
6-pin	Zettler Zetcom	10'	GEM-479	19854	\$63.95
8-pin DIN	Jeron Provider 680	8'	GEM-180	7423	\$47.95
8-pin DIN	Rauland Responder 4	8'	GEM-18	7422	\$47.95
8-pin DIN	Jeron Provider 620	8'	GEM-240	7424	\$47.95
8-pin DIN	Intercall	10'	GEM-300	7425	\$47.95
8-pin DIN	TekTone Tek-CARE 400	10'	GEM-476	7432	\$47.95
8-pin Modular	Critical Alert, Intego, TekTone, Wescom, West-Com	10'	GEM-471	7430	\$47.95
9-pin	Zettler Sentinel 400	10'	GEM-160	7421	\$59.95
10-pin Modular	West-Com	8'	GEA-480	15014	\$47.95

# SPECIALTY CALL CORDS

## PADCALL®

- Large call surface (3" diameter)
- Sensitive, air-activated switch
- Gripper feet hold pendant in place
- Linen clip securely attaches to bedding
- Custom lengths available



PLUG TYPE	NURSE CALL SYSTEM	DESCRIPTION	MODEL NUMBER	PART NUMBER	PRICE
1/4" plug	Universal	8'	GEA-030	7351	\$50.95
15-pin	SimplexGrinnell EZCare	8'	GEA-360	7379	\$144.95
9-pin	Zettler Sentinel 500	8', normally closed	GEA-195	7371	\$88.95
8-pin Modular	Critical Alert, Intego, TekTone, Wescom, West-Com	8'	GEA-145	7364	\$72.95
8-pin DIN	Intercall	8'	GEA-138	7361	\$72.95
8-pin DIN	Jeron Provder 680	8'	GEA-135	7359	\$72.95
8-pin DIN	Jeron Provider 620	8'	GEA-135R	7360	\$74.95
8-pin DIN	Rauland	8'	GEA-130	7357	\$72.95
8-pin DIN	TekTone	8'	GEA-139	7362	\$72.95
10-pin Modular	West-Com	8'	GEA-146	7365	\$80.95

## PRESSCALL®

- Air activated
- Fits comfortably in patient's palm
- Available in dual and single styles
- Linen clip securely attaches to bedding
- Custom lengths available



PLUG TYPE	NURSE CALL SYSTEM	DESCRIPTION	MODEL NUMBER	PART NUMBER	PRICE
1/4" plug	Universal	8'	GEP-140	7441	\$39.95
1/4" plug	Universal	8', Dual TV, Nurse	GEP-300	7452	\$128.95
1/4" plug	Universal	8', Dual Nurse	GEP-210	7445	\$73.95
15-pin	SimplexGrinnell EZCare	8'	GEP-670	7472	\$136.95
8-pin DIN	Intercall	12'	GEP-262	7449	\$67.95
8-pin DIN	Jeron	8'	GEP-265	7450	\$61.95
8-pin DIN	Jeron Provider 620	10'	GEP-395	7457	\$67.95
8-pin DIN	Rauland	8'	GEP-260	7447	\$61.95
8-pin DIN	TekTone	8'	GEP-660	7471	\$61.95
8-pin Modular	Critical Alert, Intego, TekTone, Wescom, West-Com	8'	GEP-310	7453	\$61.95

# ADAPTORS



The needs of some patients may require that multiple nurse call devices are connected to your nurse call system. Our line of adaptors will give your nurse call system the flexibility to handle this increased demand. They're easy to install, feature strain relief on the cable, and are available with numerous receptacle options. Please call your Curbell representative to discuss the most effective solution for your specific needs.

## BOX ADAPTOR

A mountable box style adaptor allows you to safely expand the interface capabilities of the in-room patient station. Curbell offers adaptors that have been tested directly with the nurse call systems to verify patient and system safety.



## CONVERSION ADAPTOR

Specifically for instances when you have a single universal 1/4" nurse call device, but not a matching receptacle on the patient station, the conversion adaptor effectively changes the plug style.



## JUMPER ADAPTOR

Help extend the life of your patient station and nurse call device cable with breakaway cables. Choose from 8-pin DIN, 9-pin DIN or 10-pin Modular styles.









Curbell ensures that these products are validated to meet your intended needs for nurse call communication. Please contact Curbell with any questions regarding these adaptors.

# ADAPTORS









## Amplion Alert

PLUG STYLE	RECEPTACLE 1	RECEPTACLE 2	RECEPTACLE 3	STYLE	MODEL #	PART #	PRICE
 15 Pin	 15 Pin	 1/4" jack	–	Box	ADP-1506F-101	21077	93.95





















## Dukane System 2000, 2010, 2030, 2070

PLUG STYLE	RECEPTACLE 1	RECEPTACLE 2	RECEPTACLE 3	STYLE	MODEL #	PART #	PRICE
 13 Pin	 13 Pin	 1/4" jack	–	Box	ADP-0413-101	3271	87.95
 13 Pin	 13 Pin	 1/4" jack	 1/4" (TV)	Box	ADP-0413-106	3274	97.95







## Dukane ProCare 4000, 6000, System 2070, Ascom/GE Telligence

PLUG STYLE	RECEPTACLE 1	RECEPTACLE 2	RECEPTACLE 3	STYLE	MODEL #	PART #	PRICE
 18-pin	 18-pin	 1/4" jack	 1/4" (TV)	Box	ADP-1802-103	3354	121.95
 18-pin	 18-pin	 18-pin	–	Box	ADP-1802-104	3355	126.95
 18-pin	 1/4" jack	–	–	Conversion	AD-185	3241	19.95













## Executone Care/Com, Futura

PLUG STYLE	RECEPTACLE 1	RECEPTACLE 2	RECEPTACLE 3	STYLE	MODEL #	PART #	PRICE
 7-pin Care/Com	 7-pin Care/Com	 1/4" jack	–	Box	ADP-0307-103	3248	76.95
 7-pin Care/Com	 7-pin Care/Com	 1/4" jack	 1/4" (TV)	Box	ADP-0307-109	3253	86.95
 7-pin Care/Com	 7-pin Care/Com	 7-pin Care/Com	–	Box	ADP-0307-106	3251	100.95
 7-pin Futura	 7-pin Futura	 1/4" jack	–	Box	ADP-0307-112	3254	76.95
 7-pin Futura	 7-pin Futura	 1/4" jack	 1/4" (TV)	Box	ADP-0307-113	3255	86.95
 7-pin Futura	 7-pin Futura	 7-pin Futura	–	Box	ADP-0307-111	14299	100.95









## Hill-Rom COMposer, COMlinx, NaviCare

PLUG STYLE	RECEPTACLE 1	RECEPTACLE 2	RECEPTACLE 3	STYLE	MODEL #	PART #	PRICE
 20-pin	 20-pin	 1/4" jack	–	Box	ADP-2020-101	3367	140.95
 20-pin	 20-pin	 1/4" jack	 1/4" (TV)	Box	ADP-2020-102	3368	150.95

## Critical Alert, Intego, TekTone, Wescom, West-Com











PLUG STYLE	RECEPTACLE 1	RECEPTACLE 2	RECEPTACLE 3	STYLE	MODEL #	PART #	PRICE
 8-pin Modular	 8-pin Modular	 1/4" jack	–	Box	ADP-0808-101	3322	77.95
 8-pin Modular	 8-pin Modular	 1/4" jack	 1/4" (TV)	Box	ADP-0808-102	3323	87.95
 8-pin Modular	 8-pin Modular	 8-pin Modular	–	Box	ADP-0808-103	3324	91.95
 8-pin Modular	 1/4" jack	–	–	Conversion	AD-030	3212	30.95

## Jeron Provider 680 and 790





















PLUG STYLE	RECEPTACLE 1	RECEPTACLE 2	RECEPTACLE 3	STYLE	MODEL #	PART #	PRICE
 8-pin DIN	 8-pin DIN	 1/4" jack	–	Box	ADP-0800-101	3283	79.95
 8-pin DIN	 1/4" jack	–	–	Conversion	AD-110	3233	29.95
 8-pin DIN	 8-pin DIN	 1/4" jack	–	Jumper	JUP-1101-002	18194	52.95

The adaptors shown on these pages are a small sample of what we offer. If you need more help determining what solution is right for your situation, call your Curbell Sales Representative at 1-800-235-7500.











## Rauland Responder III

PLUG STYLE	RECEPTACLE 1	RECEPTACLE 2	RECEPTACLE 3	STYLE	MODEL #	PART #	PRICE
 12-pin	 12-pin	 1/4" jack	–	Box	ADP-0412-101	3266	79.95
 12-pin	 12-pin	 1/4" jack	 1/4" (TV)	Box	ADP-0412-102	3267	89.95
 12-pin	 12-pin	 12-pin Rauland	–	Box	ADP-0412-103	3268	97.95







## Rauland Responder III+, IV

PLUG STYLE	RECEPTACLE 1	RECEPTACLE 2	RECEPTACLE 3	STYLE	MODEL #	PART #	PRICE
 8-pin DIN	 8-pin DIN	 1/4" jack	–	Box	ADP-0800-113	3294	79.95
 8-pin DIN	 8-pin DIN	 1/4" jack	 1/4" (TV)	Box	ADP-0800-117	3297	89.95
 8-pin DIN	 8-pin DIN	 8-pin DIN	–	Box	ADP-0800-118	3298	83.95
 8-pin DIN	 1/4" jack	–	–	Conversion	AD-120	3235	29.95
 8-pin DIN	 8-pin DIN	 1/4" jack	–	Jumper	JUP-1101-001	18193	52.95
 8-pin DIN	 8-pin DIN	 8-pin DIN	–	Jumper	JUP-1100-002	18154	48.95
 8-pin DIN	 8-pin DIN	–	–	Jumper	JUP-1000-010-002	8482	18.95







## Rauland Responder 4000

PLUG STYLE	RECEPTACLE 1	RECEPTACLE 2	RECEPTACLE 3	STYLE	MODEL #	PART #	PRICE
 8-pin DIN	 8-pin DIN	 8-pin DIN	–	Box	ADP-0800-110	3291	83.95
 8-pin DIN	 8-pin DIN	 8-pin DIN	 1/4" jack	Box	ADP-0800-115	3296	93.95
 8-pin DIN	 8-pin DIN	 8-pin DIN	–	Jumper	JUP-1100-002	18154	48.95





## SimplexGrinnell EZCare

PLUG STYLE	RECEPTACLE 1	RECEPTACLE 2	RECEPTACLE 3	STYLE	MODEL #	PART #	PRICE
 15-pin	 15-pin	 1/4" Jack	–	Box	ADP-1500F-101	3349	160.95
 15-pin	 15-pin	 1/4" Jack	 1/4" Jack (TV)	Box	ADP-1500F-102	3350	170.95



## Sylvania/HCE

PLUG STYLE	RECEPTACLE 1	RECEPTACLE 2	RECEPTACLE 3	STYLE	MODEL #	PART #	PRICE
 20-pin	 20-pin	 1/4" Jack	 1/4" Jack (TV)	Box	ADP-0320F-104	3263	96.95
 20-pin	 1/4" Jack	–	–	Conversion	AD-140	3236	\$32.95











## West-Com

PLUG STYLE	RECEPTACLE 1	RECEPTACLE 2	RECEPTACLE 3	STYLE	MODEL #	PART #	PRICE
 10-pin Modular	 10-pin Modular	 1/4" jack	–	Box	ADP-1010-102	3341	82.95
 10-pin Modular	 10-pin Modular	–	–	Jumper	JU06-311	8124	18.95

## Zettler Sentinel 500

PLUG STYLE	RECEPTACLE 1	RECEPTACLE 2	RECEPTACLE 3	STYLE	MODEL #	PART #	PRICE
 9-pin D-sub	 9-pin D-sub	 1/4" jack	–	Box	ADP-0909-103	3329	88.95

## Universal 1/4" and 37-Pin

PLUG STYLE	RECEPTACLE 1	RECEPTACLE 2	RECEPTACLE 3	STYLE	MODEL #	PART #	PRICE
 1/4" plug	 1/4" jack	 1/4" jack	–	Jumper	JUP-1052-002-001	8507	34.95
 1/4" plug	 1/4" jack	–	–	Jumper	JUP-1050-001-001	8498	17.95
 37-pin D-sub	 37-pin D-sub	 1/4" jack	–	Box	ADP-3703-101	16659	103.95
 37-pin D-sub	 1/4" jack	–	–	Conversion	AD-155	3237	21.95

# WALL PLATES

- For standard or custom head- or foot-end installations
- Optional pigtails available for quicker installation
- Plastic plates available



WPA-0001



WPA-0005



WPA-0017

## 1/4" Wall Plates

GANGS	SOCKET 1	SOCKET 2	PIGTAILS	DUPLEX	MODEL NUMBER	PART NUMBER	PRICE
1	1/4"	—	No	No	WPA-0002	13850	\$14.25
1	1/4"	Coax	No	No	WPA-0005	13852	\$15.25
1	1/4"	Coax	Yes	No	WPA-0152	13886	\$16.50
1	1/4"	1/4"	Yes	No	WPA-0182	13888	\$19.75
1	1/4"	—	Yes	No	WPA-0183	13889	\$16.50
2	1/4"	Coax	No	Yes	WPA-0036	13865	\$24.25
2	1/4"	Coax	Yes	Yes	WPA-0185	13890	\$32.95
3	1/4"	Coax	Yes	Yes	WPA-0419	13919	\$34.00

## 5-Pin RCA Wall Plates

GANGS	SOCKET 1	SOCKET 2	PIGTAILS	DUPLEX	MODEL NUMBER	PART NUMBER	PRICE
1	5-pin RCA	Coax	No	No	WPA-0006	13853	\$15.25
1	5-pin RCA	—	No	No	WPA-0012	13856	\$13.25
1	5-pin RCA	Coax	Yes	No	WPA-0179	13887	\$18.95
1	5-pin RCA	—	Yes	No	WPA-0513	13931	\$16.50
2	5-pin RCA	Coax	No	Yes	WPA-0063	13870	\$24.25

## 6-Pin Zenith Wall Plates

GANGS	SOCKET 1	SOCKET 2	PIGTAILS	DUPLEX	MODEL NUMBER	PART NUMBER	PRICE
1	6-pin Zenith	Coax	No	No	WPA-0001	13849	\$21.95
1	6-pin Zenith	Coax	Yes	No	WPA-0004	13851	\$24.20
1	6-pin Zenith	6-pin Zenith	No	No	WPA-0008	13854	\$33.15
1	6-pin Zenith	—	No	No	WPA-0010	13855	\$19.95
1	6-pin Zenith	—	Yes	No	WPA-0088	13874	\$20.95
2	6-pin Zenith	Coax	No	Yes	WPA-0017	13859	\$30.90
2	6-pin Zenith	Coax	Yes	Yes	WPA-0466	13923	\$32.95
3	6-pin Zenith	Coax	Yes	Yes	WPA-0322	13947	\$41.95

## Coax Wall Plates

GANGS	SOCKET 1	SOCKET 2	PIGTAILS	DUPLEX	MODEL NUMBER	PART NUMBER	PRICE
1	Coax	—	No	No	WPA-0198	13895	\$12.00

## RJ45 Wall Plates

GANGS	SOCKET 1	SOCKET 2	SOCKET 3	PIGTAILS	DUPLEX	MODEL NUMBER	PART NUMBER	PRICE
1	RJ45	Coax	6-pin Zenith	Yes	No	WPA-0767	13991	\$52.65
1	RJ45	Coax	1/4"	Yes	No	WPA-0737	13977	\$45.95

# TV JUMPER CABLES

Hospitals and installers have relied on Curbell for years to supply television jumper cables with a wide variety of plug styles, and our close relationships with healthcare television manufacturers ensures that the wiring is correct and up-to-date.

- Dozens of configurations
- Standard 36" length
- Custom lengths available



PLUG END 1	PLUG END 2	MODEL NUMBER	PART NUMBER	PRICE
1/4" Female	1/4" plug	JU06-550	8132	\$20.95
1/4" Female	1/8" 3-Conductor	JU36-781	8322	\$13.95
1/4" Female	1/8" 4-Conductor	JU36-513	8284	\$14.95
1/4" Female	6-pin Zenith	JU36-430	8270	\$19.95
1/4"	1/4" plug	JU36-030	8211	\$12.95
1/4"	1/8" 3-Conductor	JU36-780	8321	\$12.95
1/4"	1/8" 4-Conductor	JU36-503	8278	\$13.95
1/4"	5-pin Female RCA	JU36-005	8201	\$17.95
1/4"	5-pin RCA	JU36-040	8213	\$12.95
1/4"	5-pin DIN	JU36-TBD	TBD	Call
1/4"	RJ12	JU36-280	8259	\$12.95
1/4"	6-pin Zenith	JU36-050	8215	\$12.95
1/8" 3-Conductor	1/8" 3-conductor	JU36-777	8319	\$11.95
1/8" 3-Conductor	5-pin	JU36-770	8317	\$11.95
1/8" 3-Conductor	6-pin Zenith	JU36-720	8310	\$12.95
1/8" 4-Conductor	5-pin	JU36-505	8280	\$12.95
1/8" 4-Conductor	6-pin Zenith Female	JU36-516	8285	\$22.65
1/8" 4-Conductor	6-pin Zenith	JU36-506	8281	\$13.95
5-pin RCA	5-pin RCA	JU36-070	8219	\$12.95
5-pin RCA	RJ12	JU36-140	8237	\$12.95
6-pin Zenith	5-pin Female RCA	JU36-330	8265	\$20.95
6-pin Zenith	5-pin RCA	JU36-090	8224	\$12.95
6-pin Zenith	5-pin DIN	JU36-TBD	TBD	Call
6-pin Zenith (3 pins wired)	6-pin Zenith (3 pins wired)	JU36-110	8228	\$12.95
6-pin Zenith (all pins wired)	6-pin Zenith (all pins wired)	JU36-120	8233	\$13.95
6-pin Zenith	RJ12	JU36-150	8239	\$13.95
6-pin Zenith	bare wire	JU36-095	8225	\$8.95
Coax	Coax	JU36-010	8204	\$4.95
RJ45	6-pin Zenith	JU36-TBD	TBD	Call
RJ45	1/8" 3-conductor	JU36-TBD	TBD	Call



# DUMMY PLUGS

Curbell's dummy plugs eliminate cord out alarms when the signaling device isn't plugged in. They are available for virtually any nurse call system or dedicated in-wall bed port.



DP-100



DP-010



DPG-0100-100

PLUG END	CORD	NOTES	MODEL NUMBER	PART NUMBER	PRICE
1/4" plug	—	Metal Plug	DP-010	6832	\$3.95
1/4" plug	6" Poly Cord	Metal Plug	DP-020	6834	\$5.25
1/4" plug	6" Poly Cord	Metal Plug, Normally Closed	DP-025	6835	\$5.25
1/4" plug	6" Poly Cord	Plastic, White	DPG-0100-206	20173	\$2.75
1/4" plug	—	Plastic, White	DPG-0100-100	20172	\$1.95
10-pin Modular	6" Poly Cord		DP-255	6862	\$8.95
12-pin Rauland	—	Jump 7 and 10	DP-200	6856	\$11.95
36-pin centronics	7" Nylon-Coated Wire Rope	7 and 25, 10 and 11	DP-480	6869	\$11.95
36-pin centronics	7" Nylon-Coated Wire Rope	7 and 25, 8 and 9, 10 and 11	DP-470	6868	\$11.95
37-pin universal	6" Poly Cord	7 and 25, 8 and 9, 10 and 11	DP-110	6849	\$12.95
37-pin universal	6" Poly Cord	7 and 25, 10 and 11	DP-100	6846	\$11.95
RJ45	—	Jump 4 and 5	DP-082	6844	\$8.95
8-pin DIN Jeron	—	—	DP-062	6840	\$8.95
8-pin DIN Rauland	6" Poly Cord	—	DP-140	6852	\$9.95
9-pin Zettler	6" Poly Cord	Sentinel 400, Jump 7 and 8	DP-160	6854	\$10.95
9-pin Zettler	6" Poly Cord	Sentinel 500, Jump 4 and 9	DP-165	6855	\$10.95

See pages [48-78](#) for specific dummy plugs for your nurse call system



## BED CABLES AND ACCESSORIES

### BRING YOUR BEDS TO LIFE





With a custom communication cable from Curbell Medical, a bed comes to life. It becomes a communication center, linking the patient to nurse call systems, televisions, and other room technologies — even delivering potentially life-saving data. For more than 50 years, we have made sure that patients can expect the best possible experience; and our people make sure that our customers can expect the same. Let us help you find the right solution for you and your beds.

# CHOOSING THE RIGHT SOLUTION



## Which type of cable is right for you?

Between the dozens of bed models, connector styles, and nurse call systems, there are hundreds of bed communication options to choose from. You can learn more about those options on the following pages. If you need more help determining what solution is right for you and your situation, call your Curbell sales representative at 1-800-235-7500.

	 BREAKAWAY CABLE (pages 33-39)	 STANDARD INLINE CABLE (page 40)	 STANDARD 90° CABLE (page 40)	 BED-TO-NURSE CALL CABLE (pages 41)
You're plugging into a standard 37-pin receptacle or Hill-Rom® Bed Interface Unit	●	●	●	
Space is too tight for an inline cable	●		●	
You're plugging directly into a patient station	●	●	●	●
You want to control lights or TV from the bed	●	●	●	●
You're having issues with plug and receptacle damage	●		●	●
Allows standardized bed connection in rooms with different bed or nurse call systems	●			



## BREAKAWAY CABLES

### PROTECT YOUR WALLS AND YOUR PATIENTS

If your bed cables and wall receptacles are being damaged, Curbell's Breakaway Cables can help put an end to it. The unique two-piece design safely breaks apart at a point away from the wall receptacle or wall patient station, reducing cable replacement and receptacle repair costs, and most importantly, minimizing patient risk.

# SOLVE THESE COMMON PROBLEMS

## [1] NON-STANDARDIZED BEDS AND NURSE CALL SYSTEMS

If your facility has multiple types of nurse call systems or beds, moving beds from room to room can be a challenge.

Curbell's breakaway cables give you a common connection in every room regardless of bed type or nurse call system. One section is permanently attached at the wall, and the other section is permanently attached to the bed. Use them throughout your facility, and you can freely move beds from room to room.

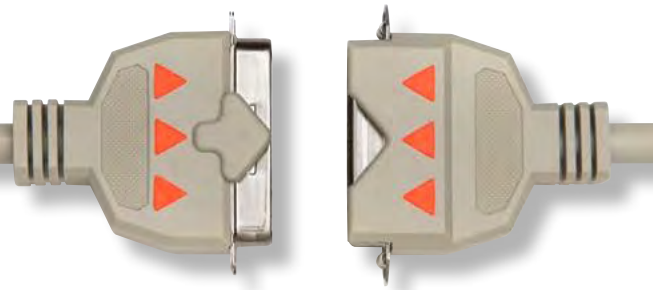

## [2] RECEPTACLE AND CABLE DAMAGE



Is this a common sight after a bed gets moved? It doesn't need to be.

Aside from being a costly repair, a damaged wall receptacle or patient station can put a room out of service for days. By using a breakaway cable from Curbell, you minimize the chance of this type of damage happening. If the bed is moved without disconnecting the cable, the unique two-piece design safely breaks apart at a point away from the wall, reducing cable replacement and receptacle repair costs, and most importantly, minimizing patient risk.



Cables and wall receptacles incur damage when the bed cable isn't unplugged before moving the bed.



The pinless connectors on our breakaway cables have no pins to break.

## [3] UNUSED BED FEATURES



Are the advanced features of your beds going unused because it's too much trouble to plug them in?

With a bed communication cable from Curbell Medical, a bed comes to life. It becomes a communication center, linking the patient to nurse call systems, televisions, and other room technologies — even delivering potentially life-saving data. Using a breakaway cable lets you use all the features of the bed while having a simple and quick way to disconnect the bed when it needs to be moved.

# STANDARD BREAKAWAY CABLES

## USING THE BREAKAWAY CABLE IS SIMPLE

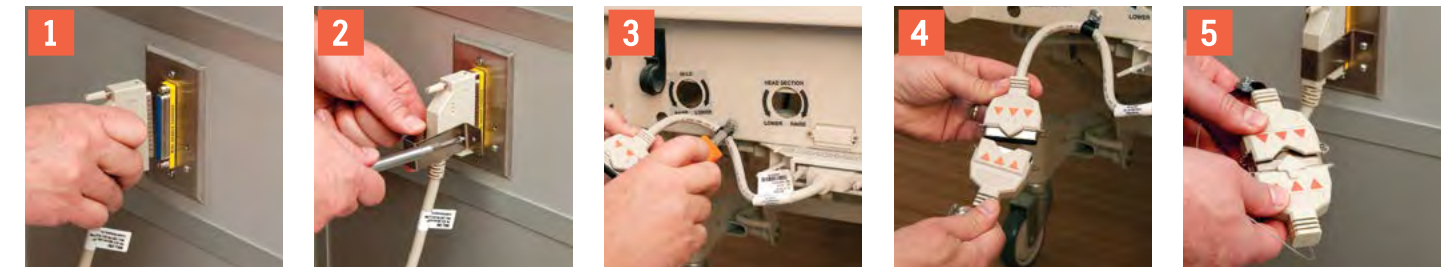

1 Plug the wall end of the cable into the wall plate and tighten the thumbscrews.

2 Install the bracket to permanently mount the cable (see page 38-39 for information on brackets).

3 Plug the cable into the bed, tighten the thumbscrews, and screw the strain relief clamp into the bed to permanently mount the cable.

4 Connect the breakaway cable's pinless connectors.

5 When moving the bed, disconnect the cables and place the dummy plug into the wall end of the cable.

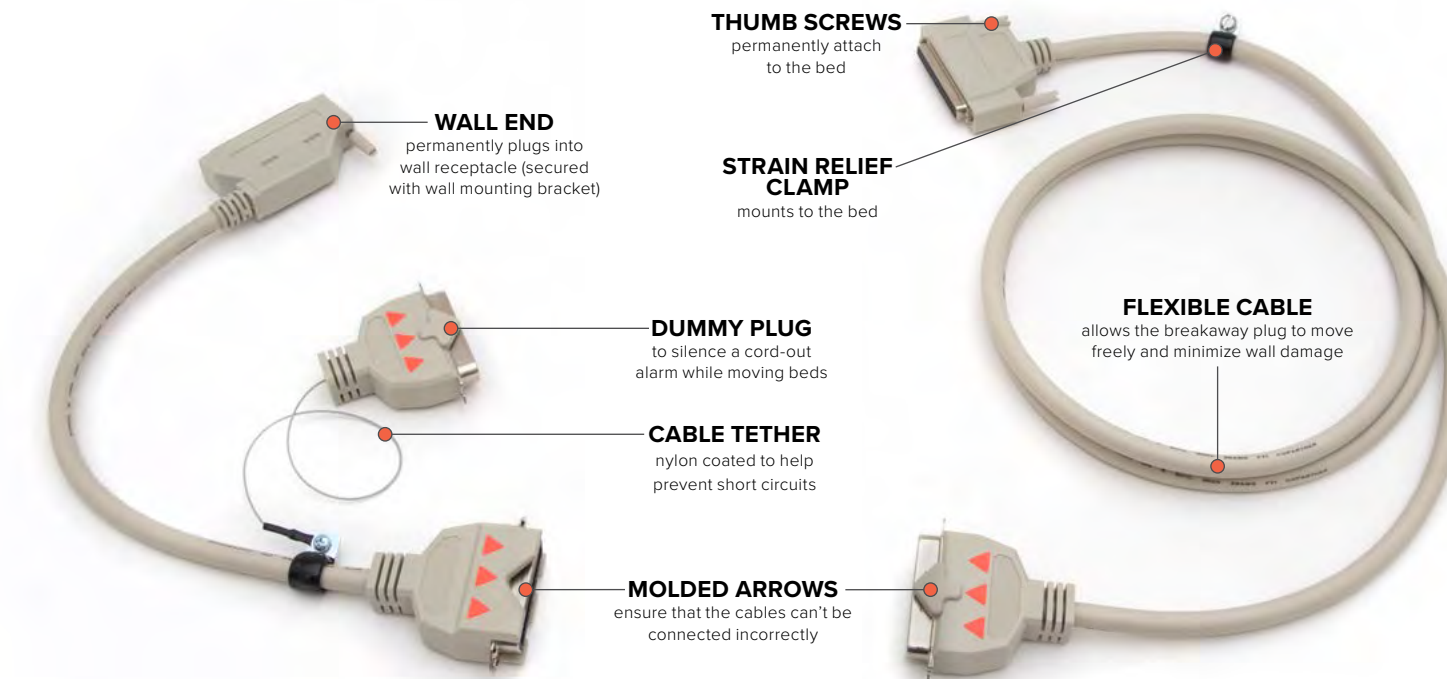

## STANDARD 37-PIN STYLES (SEE PAGES 36-37 FOR OTHER CONNECTIONS)

Part numbers for most common standard 37-pin connections are listed below.

Wall and bed half cables are also available separately in 1, 2, 4, 6, 8, 10, 12, and 15 foot lengths.

WALL END	LENGTH	BED END	LENGTH	MODEL #	PART #	PRICE
37-Pin male, straight inline	1 ft.	37-Pin female, Hill-Rom	6 ft.	BCC-3002-A01-A06-001	3511	\$61.75
37-Pin male, 90° angle				BCC-3003-A01-A06-001	3535	\$61.75
37-Pin male, straight inline	6 ft.		1 ft.	BCC-3002-A06-A01-001	3523	\$61.75
37-Pin male, 90° angle				BCC-3003-A06-A01-001	3552	\$61.75
37-Pin male, straight inline	1 ft.		6 ft.	BCC-3002-A01-E06-001	3517	\$61.75
37-Pin male, 90° angle				BCC-3003-A01-E06-001	3540	\$61.75
37-Pin male, straight inline	6 ft.	37-Pin male, Stryker	1 ft.	BCC-3002-A06-E01-001	3527	\$61.75
37-Pin male, 90° angle				BCC-3003-A06-E01-001	3557	\$61.75

# BED-TO-NURSE CALL BREAKAWAY CABLES

Curbell offers Breakaway Cables that connect directly to most nurse call systems. With one of these cables, you can be assured that you're getting the maximum functionality out of your beds and nurse call system.

- Available for most beds, including those from Amico, ArjoHuntleigh®, Carroll® (CHG®), Hill-Rom®, Joerns, Kreg Medical, Linet®, Next Health, Rotec, Sizewise, Stryker®, Stryker London, and Umano Medical
- Inline or 90° 37-Pin connectors
- For most common Nurse Call systems (see chart below)
- 8' standard length, other lengths available
- One year warranty

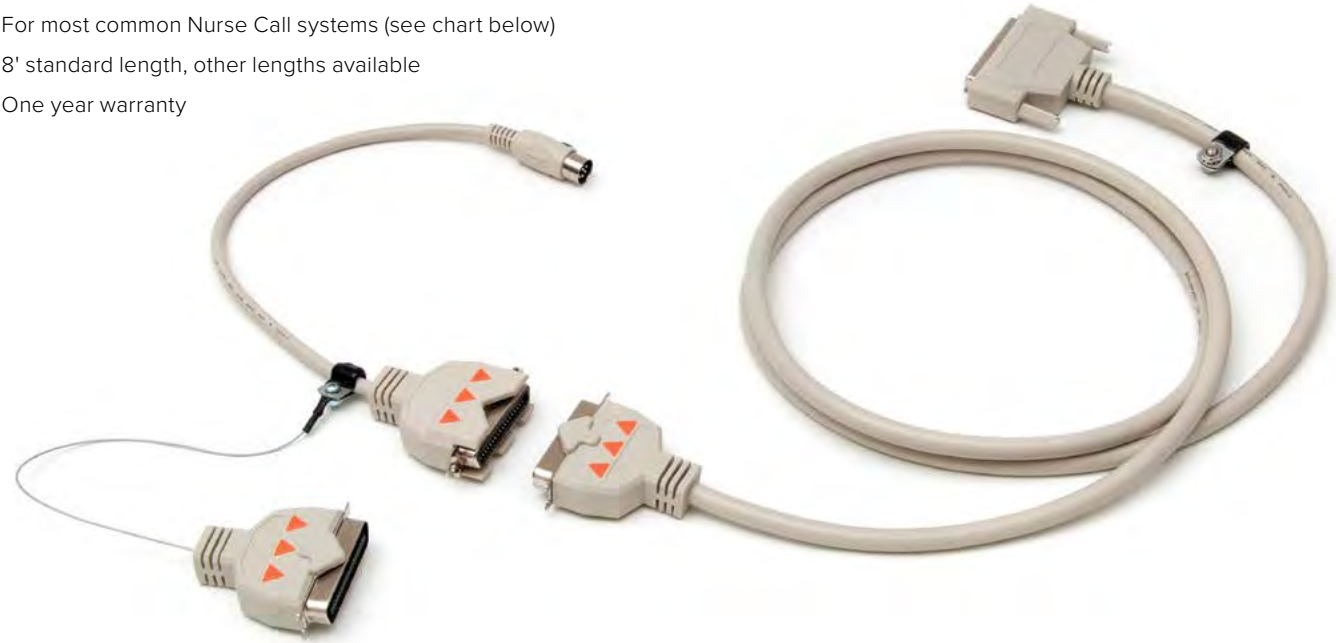

## Curbell offers breakaway cables to connect your beds to these nurse call systems:

 <b>PLUG STYLE: 1802</b> Ascom /GE® Telligence™	 <b>PLUG STYLE: 800</b> Austco® MediCom, Tacera	 <b>PLUG STYLE: 808</b> Critical Alert® /Intego® / Wescom SPS101, System 200, 1000/3000	 <b>PLUG STYLE: 417</b> Dukane ProCare 2000®, System 2070	 <b>PLUG STYLE: 1801</b> Dukane ProCare 4000, ProCare 6000, System 2070	 <b>PLUG STYLE: 1505</b> Fisher Berkeley HP Series, MMC Series
 <b>PLUG STYLE: 2020</b> Hill-Rom® COMLinx®, COMposer®, NaviCare®	 <b>PLUG STYLE: 3701</b> Hill-Rom DB37, Headwall	 <b>PLUG STYLE: 800</b> Intercall Legend II, Equinox II, Spectrum II, Ultra 6000, 6900, 9000	 <b>PLUG STYLE: 800</b> Jeron® Pro-Alert™ 640, Provider™ 680, Spectrum® Pro IR	 <b>PLUG STYLE: 800</b> Rauland Responder III+, IV, Responder 4000	 <b>PLUG STYLE: 1500</b> SimplexGrinnell® EZCare™
 <b>PLUG STYLE: 800</b> TekTone® Tek-CARE NC300 II, Tek-CARE 400	 <b>PLUG STYLE: 808</b> TekTone Tek-CARE NC300 II	 <b>PLUG STYLE: 808</b> West-Com 1000, 8000, Endeavor, Mark II	 <b>PLUG STYLE: 1010</b> West-Com Odyssey, Odyssey Plus, Novus™	 <b>PLUG STYLE: 909</b> Zettler Sentinel 400®, Sentinel 500®	

SEE PAGE 37 FOR SPECIALTY BED-TO-NURSE CALL BREAKAWAY CABLES

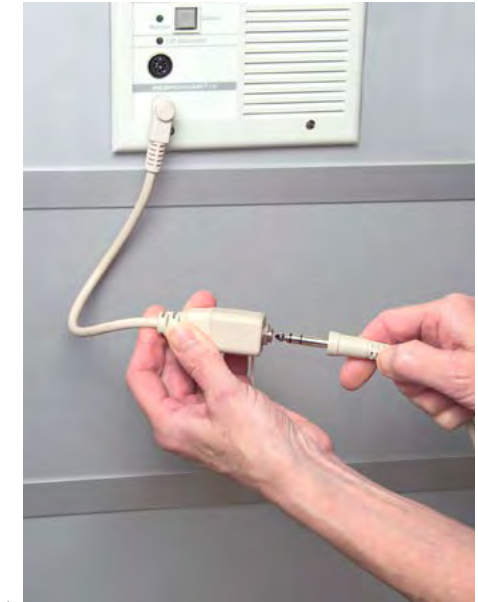

### For Ascom/GE Telligence® Patient Stations









Our breakaway cable for Telligence systems use extra long screws provide a secure fit at the patient station.

### For Rauland® Patient Stations

The 800/102 Breakaway Cable allows the wall half of the breakaway cable to be plugged directly into Rauland patient stations with an 8-pin DIN for regular nurse call and a 1/4" auxiliary port (for the bed exit alarm).

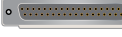
### For Patient Stations with 1/4" jacks

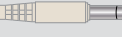
The 1/4" Breakaway Cable allows for Bed Exit and/or Nurse Call-only applications. It's a simple and reliable solution when you don't have the need or ability to use a Centronics Breakaway Cable. Call your Curbell Representative for additional plug styles.

WALL END	LENGTH	BED END	LENGTH	MODEL #	PART #	PRICE
 37-pin for Telligence (3701 plug style)	1 ft.	 Hill-Rom	6 ft.	BCC-3051-A01-A06-000	18623	\$61.75
	1 ft.	 Stryker	6 ft.	BCC-3051-A01-E06-000	18624	\$61.75
 8-pin DIN (800 plug style) and 1/4" (102 plug style)	1 ft.	 Hill-Rom	6 ft.	BCC-3070-B01-A06-001	3605	\$77.20
	1 ft.	 Stryker	6 ft.	BCC-3070-B01-E06-001	3606	\$77.20
 1/4" (102 plug style)	6"	 Hill-Rom	8 ft.	BCC-0000-002-A00-8	3426	\$44.95

**NOTE:** Call for complete breakaway cable part numbers. Part numbers shown above are based on standard wiring and may not work for your specific requirements. Wall End and Bed End half cables are also available. Call your Curbell sales representative for information about cables for other nurse call systems and custom lengths

# BREAKAWAY CABLE LOCKING SOLUTIONS

For a cable to separate at the breakaway point, it needs to be secured at both the bed end and the wall end. Curbell offers several options to secure the cable to different nurse call receptacles or Bed Interface Units.

## 37-PIN WALL PLATES AND BRACKETS

### 1 INLINE CABLE WALL PLATE/BRACKET



DESCRIPTION	MODEL #	PART #	PRICE
Allows you to secure inline breakaway cables.	WPA-0719	13971	\$29.95

### 2 90° CABLE WALL PLATE/BRACKET



DESCRIPTION	MODEL #	PART #	PRICE
Allows you to secure 90° breakaway cables.	WPA-0713	13968	\$29.95

### 3 BRACKETLESS WALL PLATE



DESCRIPTION	MODEL #	PART #	PRICE
Allows you to secure the breakaway cable using the bed cable mounting screws	WPA-0608	13944	\$11.00

### 4 DUAL 90° LOCKING BRACKET



DESCRIPTION	MODEL #	PART #	PRICE
Allows you to secure two 90° breakaway cables to an existing dual 37-pin wall plate	BRK-1007-001	17036	\$6.43

### Wall Plate Mounting

Our breakaway cable wall plates can be connected without rewiring. Just remove the existing wall plate, then connect your existing female 37-pin receptacle to the male 37-pin connector on the back of the breakaway cable wall plate.



## HILL-ROM AUDIO STATION BED CONNECTOR (ASBC) BRACKETS

### 5 INLINE ASBC CABLE BRACKET



DESCRIPTION	MODEL #	PART #	PRICE
For securing inline cables to Hill-Rom Bed ASBC Units	HDW-3007-001	19405	\$7.95

### 6 90° ASBC CABLE BRACKET



DESCRIPTION	MODEL #	PART #	PRICE
For securing 90° cables to Hill-Rom Bed ASBC Units	HDW-3006-001	19253	\$7.95

## HILL-ROM BED INTERFACE UNIT BRACKETS

### 7 BIU CABLE BRACKET



DESCRIPTION	MODEL #	PART #	PRICE
For securing inline and 90° cables to Hill-Rom Bed Interface Units	HDW-3000-001	7511	\$3.95

### 8 BIU 90° CABLE BRACKET



DESCRIPTION	MODEL #	PART #	PRICE
For securing 90° cables to Hill-Rom Bed Interface Units.	HDW-3005-001	7512	\$6.95

## ADDITIONAL PARTS

### 9 WALL OR BED CABLE BRACKET



Wall Mount

Bed Mount

DESCRIPTION	MODEL #	PART #	PRICE
For securing cables to beds or non-37-pin wall plates	HW-150	7596	\$1.50

### 10 ASCOM/GE TELLIGENCE SCREW



DESCRIPTION	MODEL #	PART #	PRICE
Longer screws for securing breakaway cables to Telligence patient stations (two are required per patient station)	HW-814	7645	\$0.75 each

## COMPATIBILITY CHART

NURSE CALL SYSTEM	37-PIN CONNECTOR LOCATION	1	2	3	4	5	6	7	8	9	10
		Inline Standard 37-Pin	90° Standard 37-Pin	Bracketless 37-Pin Wall Plate	Dual 90° 37-pin Bracket	ASBC Inline Bracket	ASBC 90° Bracket	BIU Cable Bracket	BIU 90° Cable Bracket	Wall or Bed Cable Bracket	Ascom/GE Telligence Screw
Executone	wall plate	●	●	●	●	—	—	—	—	●	—
ASCOM/GE	patient station or wall	●	●	●	●	—	—	—	—	—	●
Dukane	wall plate	●	●	●	●	—	—	—	—	●	—
Hill-Rom Composer	patient station	—	—	—	—	—	—	●	●	●	—
Hill-Rom Navicare	patient station	—	—	—	—	●	●	—	—	—	—
Critical Alert	wall plate	●	●	●	●	—	—	—	—	●	—
Jeron	wall plate	●	●	●	●	—	—	—	—	●	—
Rauland Responder 3, 4, 5	wall plate	●	●	●	●	—	—	—	—	●	—
SimplexGrinnell EZCare	wall plate	●	●	●	●	—	—	—	—	●	—
West-Com	wall plate	●	●	●	●	—	—	—	—	●	—
Zettler Sentinel 500	wall plate	●	●	●	●	—	—	—	—	●	—

# STANDARD BED COMMUNICATION CABLES

A full variety of connector types are available, enabling you to connect from the bed to your 37-pin wall receptacle, or Hill-Rom® Bed Interface Unit.

- Available for most beds, including those from Amico, ArjoHuntleigh®, Carroll® (CHG®), Hill-Rom®, Joerns, Kreg Medical, Linet®, Next Health, Rotec, Sizewise, Stryker®, Stryker London, and Umano Medical
- Solid metal pins provide the most strength and reliability
- Inline or 90° plugs
- 8' standard length, other lengths available
- One year warranty

**Solid Pins vs. Rolled Pins**





✓ **Solid Pins (Cross Section)**  
Curbell's bed cables use solid gold-plated pins to provide greater strength and stability.

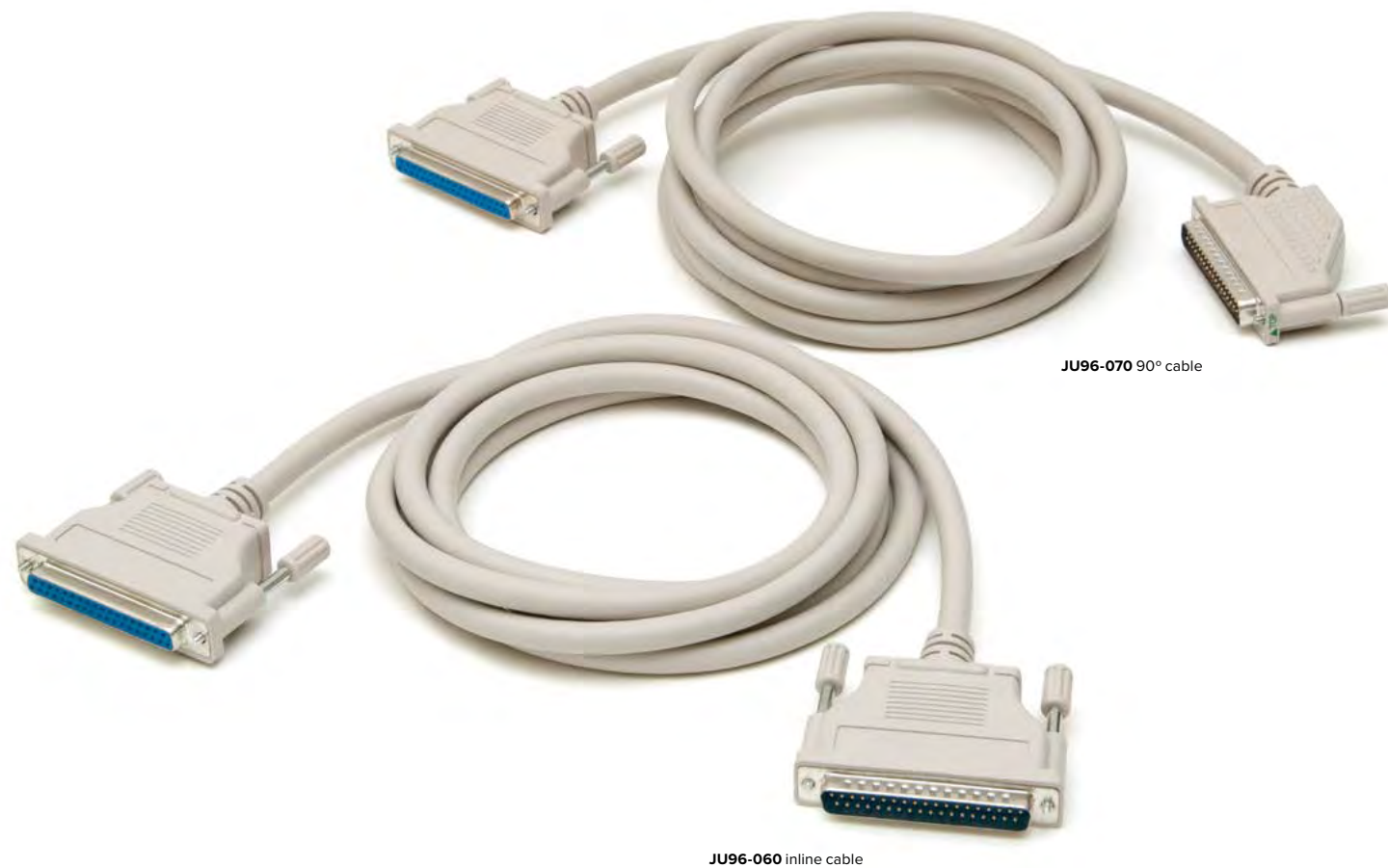

✗ **Rolled Pins (Cross Section)**  
Many inexpensive bed cables use rolled pins, which are hollow and can deform easily.

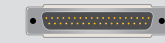
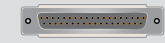
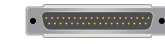
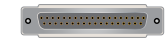
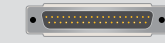
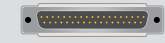

The most common 37-pin bed communication cables are shown below. Contact your Curbell sales representative for information on other styles.

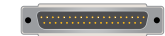
WALL END	BED END	LENGTH	MODEL #	PART #
 37-Pin male, straight inline	 37-Pin female, Hill-Rom	8 feet	BIC-3600-A00-8	8447
 37-Pin male, 90° angle	 37-Pin female, Hill-Rom	8 feet	BIC-3690-A00-8	8448
 37-Pin male, straight inline	 37-Pin male, Stryker	8 feet	BIC-3600-E00-8	8450
 37-Pin male, 90° angle	 37-Pin male, Stryker	8 feet	BIC-3600-F00-8	8449











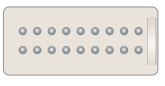

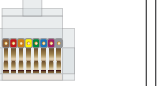



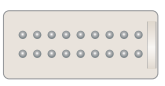
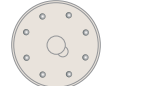

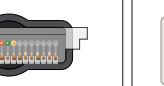



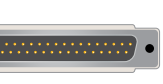
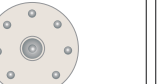

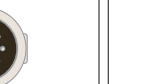

# STANDARD BED-TO-NURSE CALL CABLES

If you need to interface your beds with your Nurse Call system, Curbell can meet your specific wiring needs for the hundreds of possible configurations.

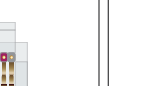
- Available for most beds, including those from Amico, ArjoHuntleigh®, Carroll® (CHG®), Hill-Rom®, Joerns, Kreg Medical, Linet®, Next Health, Rotec, Sizewise, Stryker®, Stryker London, and Umano Medical
- Inline or 90° 37-Pin connectors
- For all common Nurse Call systems (see chart below)
- 8' standard length, other lengths available
- One year warranty

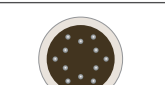

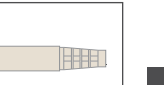
Curbell offers cables to connect your beds to these nurse call systems:







 <b>PLUG STYLE: 1802</b> Ascom /GE® Telligence™	 <b>PLUG STYLE: 800</b> Austco® MediCom, Tacera	 <b>PLUG STYLE: 808</b> Critical Alert® /Intego® / Wescom SPS101, System 200, 1000/3000	 <b>PLUG STYLE: 413</b> Dukane® System 2000, 2010, 2020, 2030	 <b>PLUG STYLE: 417</b> Dukane ProCare 2000®, System 2070	 <b>PLUG STYLE: 419</b> Dukane ProCare 2000®, System 2070
 <b>PLUG STYLE: 1801</b> Dukane ProCare 4000, ProCare 6000, System 2070	 <b>PLUG STYLE: 408</b> Ektacom HB, HV-03 Series	 <b>PLUG STYLE: 307</b> Executone® Care/Com, Futura	 <b>PLUG STYLE: 1602</b> Executone Lifesaver	 <b>PLUG STYLE: 1505</b> Fisher Berkeley HP Series, MMC Series	 <b>PLUG STYLE: 320</b> HCE/Sylvania®
 <b>PLUG STYLE: 2020</b> Hill-Rom® COMLinx®, COMposer®, NaviCare®	 <b>PLUG STYLE: 3701</b> Hill-Rom DB37, Headwall	 <b>PLUG STYLE: 702</b> Intercall® Legend II, Equinox II	 <b>PLUG STYLE: 800</b> Intercall Legend II, Equinox II, Spectrum II, Ultra 6000, 6900, 9000	 <b>PLUG STYLE: 800</b> Jeron® Pro-Alert™ 640, Provider® 680, Spectrum® Pro IR	 <b>PLUG STYLE: 412</b> Rauland® Responder® III, Responder 3000
 <b>PLUG STYLE: 800</b> Rauland Responder III+, IV, Responder 4000	 <b>PLUG STYLE: 1500</b> SimplexGrinnell® EZCare™	 <b>PLUG STYLE: 800</b> TekTone® Tek-CARE® NC300 II, Tek-CARE 400	 <b>PLUG STYLE: 808</b> TekTone Tek-CARE NC300 II	 <b>PLUG STYLE: 808</b> West-Com 1000, 8000, Endeavor, Mark II	 <b>PLUG STYLE: 1010</b> West-Com Odyssey, Odyssey Plus, Novus®
 <b>PLUG STYLE: 1012</b> West-Com Odyssey, Odyssey Plus, Novus	 <b>PLUG STYLE: 306</b> Zettler® Zetcom	 <b>PLUG STYLE: 909</b> Zettler Sentinel 400®, Sentinel 500	 <b>PLUG STYLE: 102, 103</b> Universal 1/4"	SEE PAGE 36 FOR BREAKAWAY VERSIONS OF MANY OF THESE CABLES 	

# RECEPTACLE KITS

Receptacle kits provide a dedicated bed port for professional connection to communication side rail beds

- Stainless steel wall plate
- Three dedicated pigtail sets (nurse call, entertainment, lighting) for easy routing of wire sets
- Individual conductors are stripped 1"
- One year warranty

Common styles are shown below. Contact your Curbell Sales Representative for additional styles.

PINS	LENGTH	DUMMY PLUG	MOUNTING BRACKET	MODEL #	PART #	PRICE
	37	yes	no	RK-060	13102	\$58.95
	37	yes	no	RK-070	13104	\$66.95
	37	yes	no	RK-100	13108	\$82.95
	37	no	for inline cables	RCK-1030-096	13040	\$69.95
	37	no	for 90° cables	RCK-1021-096	13038	\$69.95
	20	no	no	RCK-1010-096	13028	\$58.95



RK-060: 8' pigtail  
RK-070: 12' pigtail (pictured)  
RK-100: 20' pigtail



RCK-1030-096  
with a mounting bracket  
for inline cables



RCK-1021-096  
with a mounting bracket  
for 90° cables





RCK-1010-096  
with a 20-pin connector

# 37-PIN DUMMY PLUGS

Curbell's dummy plugs eliminate cord-out alarms when the signaling device isn't plugged in. They are available for virtually any nurse call system or dedicated in-wall bed port. Common styles are shown below. See page 30 for nurse call dummy plugs.

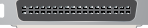

DP-100

PLUG END	CORD	JUMPED PINS	MODEL #	PART #	PRICE
	10" Nylon-Coated Wire Rope	7 and 25, 10 and 11	DP-480	6869	\$11.95
	10" Nylon-Coated Wire Rope	7 and 25, 8 and 9, 10 and 11	DP-470	6868	\$11.95
	6" Poly Cord	7 and 25, 8 and 9, 10 and 11	DP-110	6849	\$12.95
	6" Poly Cord	7 and 25, 10 and 11	DP-100	6846	\$11.95

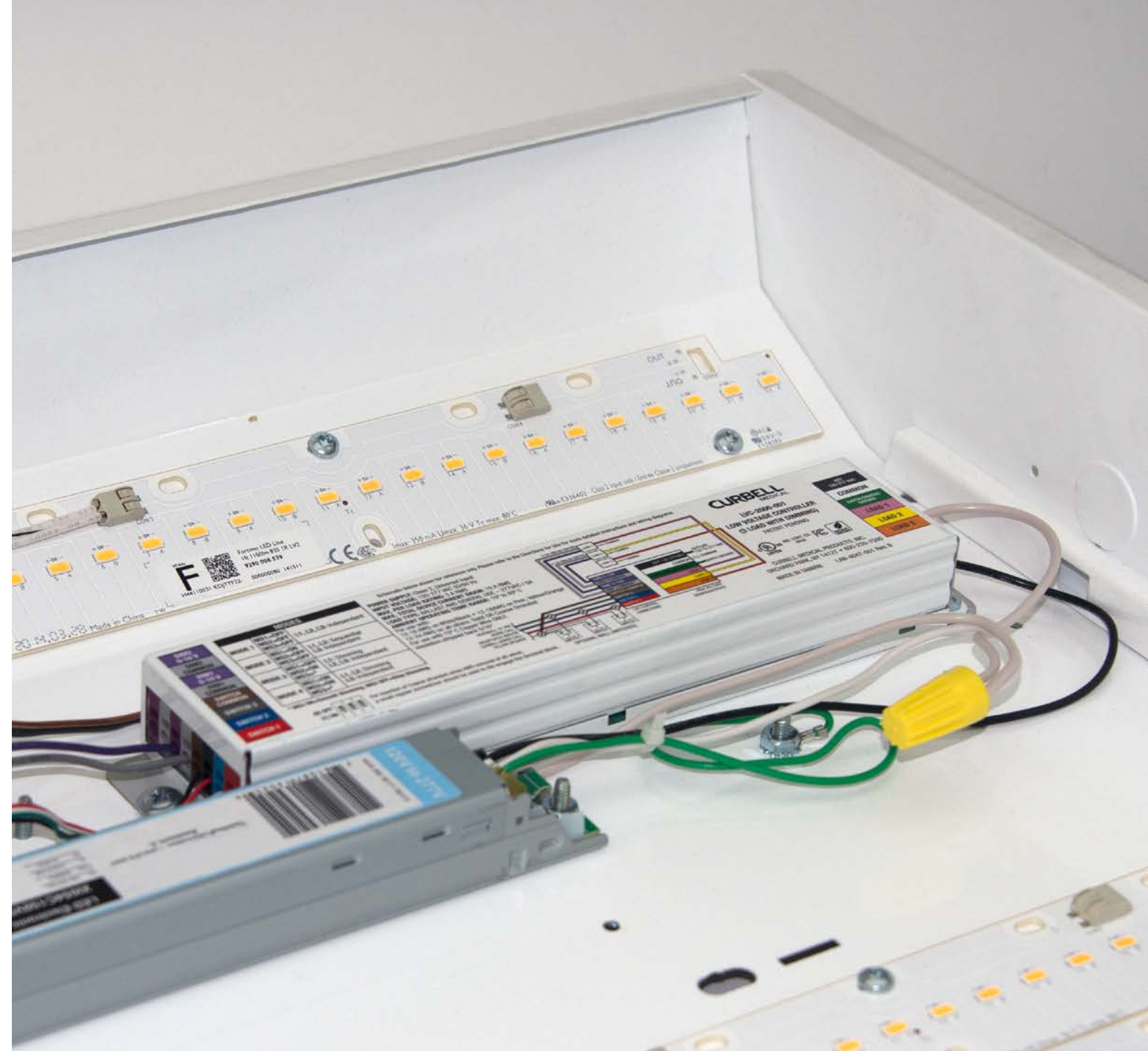

# LOW VOLTAGE CONTROLLERS

## GIVE YOUR PATIENTS CONTROL OF THEIR ENVIRONMENT

Curbell's low voltage controllers allow patients to safely operate high-voltage circuits such as lights, electric doors, and drapes with their pillow speaker or bed communication side rail. We offer models to mount either in the wall/headwall or in the lighting fixture itself. Our latest model, the LVC-2000 (page 44), is our most advanced low voltage controller yet, with the ability to control up to three loads with dimming.

# LOW VOLTAGE CONTROLLERS

## FOR LIGHTING FIXTURE APPLICATIONS

### LVC-2000 SERIES

- True universal voltage (120 to 277 VAC)
- Can control lights with multiple modes of operation:
  - Three loads independently
  - Two loads sequentially and a third Load independently
  - One load independently with 0-10V dimming control and second and third load independently
  - Two loads independently with 0-10V dimming control and a third load independently

#### LVC-2000-001

- For use with fluorescent, LED, and other lamp types
- Supports one direction dimming 100% to off

#### LVC-2000-004

- For LED lamps only
- Supports bi-directional dimming with quick on/off

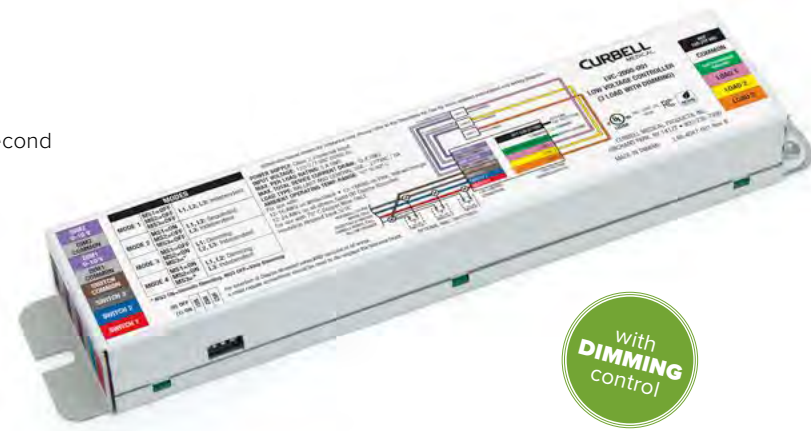

The small size allows it to mount inside a lighting fixture.

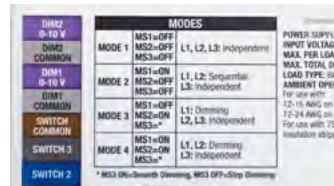

Four modes allow for numerous configurations including dimming.



Side-mounted DIP switches let you switch between modes before installation.



Color-coded push pin connectors make installation quick and simple.

	LVC-2000-001	LVC-2000-004
<b>Input Voltage</b>	120-277 VAC, 60 Hz 277 VAC, 5 A, General Use 277 VAC, 5 A, Ballast RMS current should not exceed 5 amps per load	120-277 VAC, 60 Hz 277 VAC, 5 A, General Use 277 VAC, 5 A, Ballast RMS current should not exceed 5 amps per load
<b>Load Type</b>	277 VAC, 5 A, General Use per Load 277 VAC, 5 A, Ballast per Load Maximum total device current: 10 A	277 VAC, 5 A, General Use per Load 277 VAC, 5 A, Ballast per Load Maximum total device current: 10 A
<b>Lamp Type</b>	<b>Fluorescent, LED, and other lamp types</b>	<b>LED lamps only</b>
<b>Output Voltage</b>	120-277 VAC, 60 Hz	120-277 VAC, 60 Hz
<b>Output Devices</b>	• Three 30 amp relays driven by low voltage microcontroller • ESD protected	• Three 30 amp relays driven by low voltage microcontroller • ESD protected
<b>Dimming Control</b>	<b>Current sourcing 0-10V 100% to off</b>	<b>Current sourcing 0-10V bi-directional with quick on/off</b>
<b>Low Voltage Momentary Switch Requirements</b>	Dry contacts, momentary, normally open, capable of switching 5 VDC @ 0.5 mA	Dry contacts, momentary, normally open, capable of switching 5 VDC @ 0.5 mA
<b>Switching Circuits Operation Voltage</b>	5 VDC @ 0.5 mA	5 VDC @ 0.5 mA
<b>Power Supply Classification</b>	UL listed switch mode power supply	UL listed switch mode power supply
<b>Operating Temp. Range</b>	50° to 176° F (10° to 80° C)	50° to 176° F (10° to 80° C)
<b>External wires</b>	• White/Black: 12-16 AWG, solid or coarse stranded • Pink, Yellow, Orange, Green: 12-18 AWG, solid or coarse stranded • All other wires: 12-24 AWG, solid or coarse stranded • For use only with 75° C copper wire, insulation stripped back 5/16" • Ensure that wire used exceeds corresponding voltage ratings	• White/Black: 12-16 AWG, solid or coarse stranded • Pink, Yellow, Orange, Green: 12-18 AWG, solid or coarse stranded • All other wires: 12-24 AWG, solid or coarse stranded • For use only with 75° C copper wire, insulation stripped back 5/16" • Ensure that wire used exceeds corresponding voltage ratings
<b>Mounting</b>	• Mounts next to a lighting ballast in lighting applications • May be mounted in a five gang masonry box with physical separation between high and low voltage	• Mounts next to a lighting ballast in lighting applications • May be mounted in a five gang masonry box with physical separation between high and low voltage
<b>Housing</b>	.032" Galvanized Zinc-Plated Steel	.032" Galvanized Zinc-Plated Steel
<b>Dimensions</b>	9" with tabs (L) x 1.90" (W) x 1.10" (H)	9" with tabs (L) x 1.90" (W) x 1.10" (H)
<b>Warranty</b>	Three Years	Three Years
<b>Regulatory Listings and Compliance</b>	UL/C-UL Listed to UL 508 • Compliant with FCC, Title 47 CFR 15 – Class B • RoHS compliant	UL/C-UL Listed to UL 508 • Compliant with FCC, Title 47 CFR 15 – Class B • RoHS compliant

### LC-060

- For use with fluorescent, LED, and other lamp types
- Mounts in a lighting fixture
- Controls two loads independently (on/off), or two loads sequentially (on/off)



	LC-060
<b>Input Voltage</b>	120-277 VAC, 60 Hz 277 VAC, 5 A, General Use 277 VAC, 5 A, Ballast RMS current should not exceed 5 amps per load
<b>Load Type</b>	277 VAC, 5 A, General Use per Load 277 VAC, 5 A, Ballast per Load Maximum total device current: 10 A
<b>Lamp Type</b>	Fluorescent, LED, and other lamp types
<b>Output Voltage</b>	120-277 VAC, 60 Hz
<b>Output Devices</b>	• Two 10 amp relays driven by low voltage microcontroller • ESD protected.
<b>Dimming Control</b>	NA
<b>Low Voltage Momentary Switch Requirements</b>	Dry contacts, momentary, normally open, capable of switching 5 VDC @ 0.5 mA
<b>Switching Circuits Operation Voltage</b>	5 VDC @ 0.5 mA
<b>Power Supply Classification</b>	Isolation from line voltage via a Class 2 transformer
<b>Operating Temp. Range</b>	32° to 167° F (0° to 75° C) Surrounding Air Ambient
<b>External wires</b>	White/Black: 16 AWG stranded All other wires: 18 AWG stranded
<b>Mounting</b>	• Mounts next to a lighting ballast in lighting applications • May be mounted in a five gang masonry box with physical separation between high and low voltage
<b>Housing</b>	.032" Galvanized Zinc-Plated Steel
<b>Dimensions</b>	6.75" with tabs (L) x 1.90" (W) x 1.20" (H)
<b>Warranty</b>	Three Years
<b>Regulatory Listings and Compliance</b>	UL/C-UL Listed to UL 508 • Compliant with FCC, Title 47 CFR 15 – Class B • RoHS compliant



# LOW VOLTAGE CONTROLLERS

FOR HEADWALL AND CEILING APPLICATIONS

## LC-040 AND LC-050

- ▶ For use with fluorescent, LED, and other lamp types
- ▶ Mounts in a four-gang box in the wall or ceiling
- ▶ Controls two loads independently (on/off), or two loads sequentially (on/off)

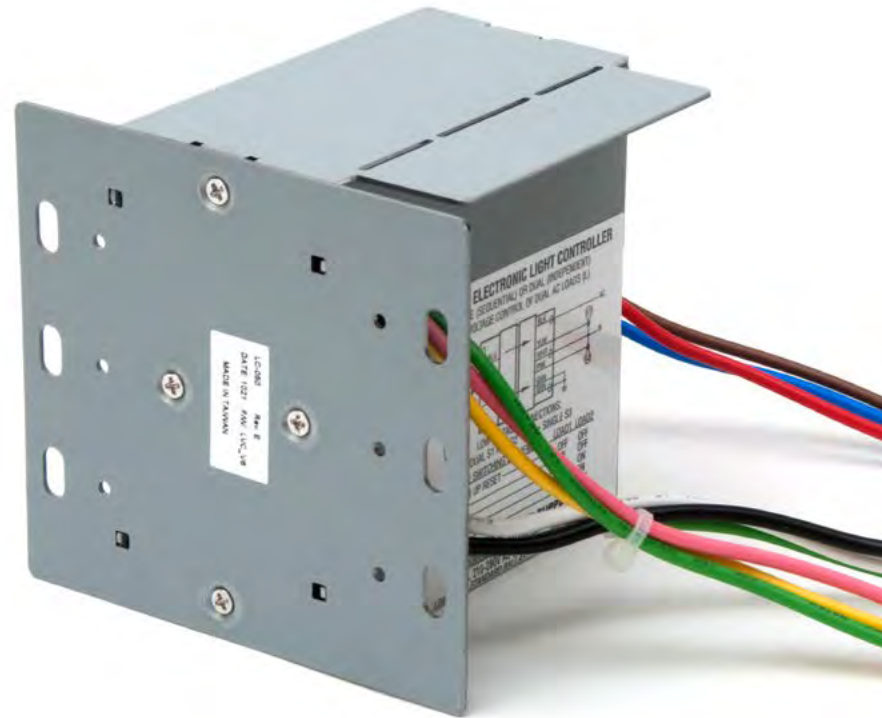

	LC-040	LC-050
<b>Input voltage</b>	100-130 VAC, 60 Hz RMS current should not exceed 5 amps	210-280 VAC, 60 Hz RMS current should not exceed 5 amps
<b>Load Type</b>	277 VAC, 5 A, General Use per Load 277 VAC, 5 A, Ballast per Load Maximum total device current: 10 A	277 VAC, 5 A, General Use per Load 277 VAC, 5 A, Ballast per Load Maximum total device current: 10 A
<b>Lamp Type</b>	Fluorescent, LED, and other lamp types	Fluorescent, LED, and other lamp types
<b>Output voltage</b>	100-130 VAC, 60 Hz	210-280 VAC, 60 Hz
<b>Output devices</b>	• Two 10 Amp relays driven by low voltage microcontroller • ESD protected	• Two 10 Amp relays driven by low voltage microcontroller • ESD protected
<b>Dimming Control</b>	NA	NA
<b>Low Voltage Momentary Switch Requirements</b>	Dry contacts, momentary, normally open, capable of switching 5 VDC @ 0.5 mA	Dry contacts, momentary, normally open, capable of switching 5 VDC @ 0.5 mA
<b>Switching circuits operation voltage</b>	5 VDC at 2.3 mA	5 VDC at 2.3 mA
<b>Power Supply Classification</b>	Isolation from line voltage via a Class 2 transformer	Isolation from line voltage via a Class 2 transformer
<b>Operating Temp. Range</b>	40° to 105° F (5° to 40° C)	40° to 105° F (5° to 40° C)
<b>External wires</b>	White/Black: 16 AWG stranded All other wires: 18 AWG stranded	White/Black: 16 AWG stranded All other wires: 18 AWG stranded
<b>Mounting</b>	3.5" deep masonry box, four gang min.	3.5" deep masonry box, four gang min.
<b>Housing</b>	.058" Galvanized Zinc-Plated Steel	.058" Galvanized Zinc-Plated Steel
<b>Dimensions</b>	3.5" (L) x 3.5" (W) x 3.8" (D)	3.5" (L) x 3.5" (W) x 3.8" (D)
<b>Warranty</b>	One Year	One Year
<b>Regulatory Listings and Compliance</b>	UL/C-UL Listed to UL 508 • Compliant with FCC, Title 47 CFR 15 – Class B • RoHS compliant	

# PILLOW SPEAKER AND REPLACEMENT PARTS PRICING

The following pages list replacement parts and repair services for nurse call systems, listed by nurse call system manufacturer. If you don't see what you're looking for, or if you have any questions, call your Curbell Medical sales representative at 1-800-235-7500.

<a href="#">Amplion Communications®</a> .....	48
<a href="#">Ascom/GE</a> .....	49
<a href="#">Critical Alert/Intego/Wescom®</a> .....	50
<a href="#">Dukane®</a> .....	51-54
<a href="#">Executone®</a> .....	55-57
<a href="#">Fisher Berkeley</a> .....	58
<a href="#">HCE/Sylvania®</a> .....	59
<a href="#">Hill-Rom®</a> .....	60-61
<a href="#">Intercall Systems®</a> .....	62
<a href="#">Jeron®</a> .....	63-65
<a href="#">Rauland®</a> .....	66-68
<a href="#">SimplexGrinnell®</a> .....	69
<a href="#">TekTone®</a> .....	70-71
<a href="#">West-Com</a> .....	72-74
<a href="#">Zettler®</a> .....	75-76
<a href="#">Applications without Nurse Call</a> .....	77-78
<a href="#">Universal Centronics Breakaway</a> .....	78
<a href="#">Pillow Speaker Parts</a> .....	79

**REPLACEMENT PILLOW SPEAKERS AND ACCESSORIES FOR:**

**Amplion Alert**



**PILLOW SPEAKERS**

TYPE	FEATURES	DIGITAL VOLUME MODEL #	PRICE	ANALOG VOLUME MODEL #	PRICE
Gen4 DirectAccess	Nurse, TV, 0-9 Keypad	4C340-0-DV	\$100.95	4C340-0-AV	\$105.95
	Nurse, TV, 0-9 Keypad, 1 Light	4C340-1-DV	\$102.95	4C340-1-AV	\$107.95
	Nurse, TV, 0-9 Keypad, 2 Lights	4C340-2-DV	\$104.95	4C340-2-AV	\$109.95
Gen4 Digital	Nurse, TV	4D340-0-DV	\$91.95	4D340-0-AV	\$96.95
	Nurse, TV, 1 Light	4D340-1-DV	\$93.95	4D340-1-AV	\$98.95
	Nurse, TV, 2 Lights	4D340-2-DV	\$95.95	4D340-2-AV	\$100.95

**NOTE:** CALL for complete Pillow Speaker part numbers. Part numbers are based on standard wiring and 8 ft. cable length. Call for additional options including ear jack, alternate cable length, and auxiliaries.

**PILLOW SPEAKER REPAIR**

DESCRIPTION	PRICE
Repair of Gen4 DirectAccess, Gen4 Digital, or Gen4 Interactive	CALL

**PILLOW SPEAKER TESTER**

DESCRIPTION	MODEL #	PART #	PRICE
Tester with one module	CT-300	6333	\$395.95
Additional module for this nurse call system	CALL	CALL	\$86.95

**PILLOW SPEAKER REPLACEMENT CABLES**

DESCRIPTION	LENGTH	MODEL #	PART #	PRICE
Replacement Cable for Gen4 Pillow Speaker	8'	CAD-3400	CALL	\$38.16

**CALL CORDS** (1/4" accessories may require an adaptor)

DESCRIPTION	LENGTH	1/4" PLUG MODEL #	PART #	PRICE
Gen4 Sealed Call Cord	8'	SCC-0101-080-N	13259	\$16.95
Gen4 Sealed Call Cord	12'	SCC-0101-120-N	13261	\$18.95
Classic Call Cord	8'	CC96-010	5822	\$14.95
Classic Call Cord	12'	CC144-010	5733	\$16.95
BreathCall	9'	GEB-010	7380	\$136.95
E-Z Call	10'	GEE-010	7402	\$64.95
Mechanical Pad	10'	GEM-0000-AGY	7407	\$43.95
PadCall	8'	GEA-030	7351	\$50.95
PressCall	8'	GEP-140	7441	\$39.95

**ADAPTORS** (see page 25 for descriptions of adaptor types)

TYPE	PLUG STYLE	RECEPTACLE 1	RECEPTACLE 2	RECEPTACLE 3	MODEL #	PART #	PRICE
Box	15-pin	15 Pin	1/4" jack	-	ADP-1506F-101	21077	\$160.95

**DUMMY PLUGS**

DESCRIPTION	MODEL #	PART #	PRICE
1/4" plug, Metal Plug, Overmolded, 6" Poly Cord	DP-020	6834	\$5.25

**REPLACEMENT PILLOW SPEAKERS AND ACCESSORIES FOR:**

**Ascom®/GE Telligence®**

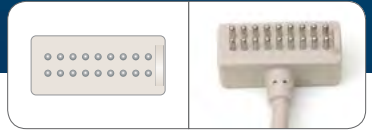

**PILLOW SPEAKERS**

TYPE	FEATURES	DIGITAL VOLUME MODEL #	PRICE	ANALOG VOLUME MODEL #	PRICE
Gen4 DirectAccess	Nurse, TV, 0-9 Keypad	4C370-0-DV	\$96.95	4C370-0-AV	\$101.95
	Nurse, TV, 0-9 Keypad, 1 Light	4C370-1-DV	\$98.95	4C370-1-AV	\$103.95
	Nurse, TV, 0-9 Keypad, 2 Lights	4C370-2-DV	\$100.95	4C370-2-AV	\$105.95
Gen4 Digital	Nurse, TV	4D370-0-DV	\$87.95	4D370-0-AV	\$92.95
	Nurse, TV, 1 Light	4D370-1-DV	\$89.95	4D370-1-AV	\$94.95
	Nurse, TV, 2 Lights	4D370-2-DV	\$91.95	4D370-2-AV	\$96.95
Gen III Analog	Nurse, TV	-	-	31802-002	\$83.65
	Nurse, TV, 1 Light	-	-	31802-001	\$87.85

**NOTE:** CALL for complete Pillow Speaker part numbers. Part numbers are based on standard wiring and 8 ft. cable length. Call for additional options including ear jack, alternate cable length, and auxiliaries.

**PILLOW SPEAKER REPAIR**

DESCRIPTION	PRICE
Repair of Gen4 DirectAccess, Gen4 Digital, Gen4 Interactive, or Gen III Analog	CALL

**PILLOW SPEAKER TESTER**

DESCRIPTION	MODEL #	PART #	PRICE
Tester with one module	CT-300	6333	\$395.95
Additional module for this nurse call system	CALL	CALL	\$95.95

**PILLOW SPEAKER REPLACEMENT CABLES**

DESCRIPTION	LENGTH	MODEL #	PART #	PRICE
Replacement Cable for Gen4 Pillow Speaker	8'	CAD-3701	CALL	\$35.16
Replacement Cable for Gen III Pillow Speaker	8'	CA31802	CALL	\$42.95

**CALL CORDS** (1/4" accessories may require an adaptor)

DESCRIPTION	LENGTH	18-PIN MODEL #	PART #	PRICE	1/4" PLUG MODEL #	PART #	PRICE
Gen4 Sealed Call Cord	8'	SCC-3701-820-U	13281	\$42.95	SCC-0101-080-U	13260	\$16.95
Gen4 Sealed Call Cord	12'	SCC-3701-C20-U	13283	\$46.95	SCC-0101-120-U	13262	\$18.95
Classic Call Cord	8'	-	-	-	CC96-010	5822	\$14.95
Classic Call Cord	12'	CC144-112	5742	\$44.95	CC144-010	5733	\$16.95
BreathCall	9'	-	-	-	GEB-010	7380	\$136.95
E-Z Call	10'	-	-	-	GEE-010	7402	\$64.95
Mechanical Pad	10'	GEM-477	7433	\$48.95	GEM-0000-AGY	7407	\$43.95
PadCall	8'	-	-	-	GEA-030	7351	\$50.95
PressCall	8'	-	-	-	GEP-140	7441	\$39.95

**ADAPTORS** (see page 25 for descriptions of adaptor types)

TYPE	PLUG STYLE	RECEPTACLE 1	RECEPTACLE 2	RECEPTACLE 3	MODEL #	PART #	PRICE
Box	18-pin	18-Pin	1/4" jack	1/4" jack	ADP-1802-103	3354	\$121.95
Box	18-pin	18-Pin	18-Pin	1/4" (TV)	ADP-1802-104	3355	\$126.95
Conversion	18-pin	18-Pin	1/4" (TV)	-	AD-185	3241	\$19.95

**DUMMY PLUGS**

DESCRIPTION	MODEL #	PART #	PRICE
1/4" plug, Metal Plug, Overmolded, 6" Poly Cord	DP-020	6834	\$5.25
18-Pin, Pins 8 and 10 Jumped, 6" Poly Cord	DPG-1802-011	6874	\$14.95

**REPLACEMENT PILLOW SPEAKERS AND ACCESSORIES FOR:**

**Critical Alert/Wescom/Intego® SPS101, System 200, 1000/3000**

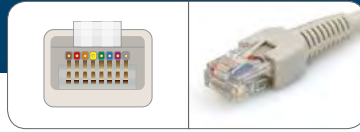

**PILLOW SPEAKERS**

TYPE	FEATURES	DIGITAL VOLUME MODEL #	PRICE	ANALOG VOLUME MODEL #	PRICE
Gen4 DirectAccess	Nurse, TV, 0-9 Keypad	4C215-0-DV	\$87.95	4C215-0-AV	\$92.95
	Nurse, TV, 0-9 Keypad, 1 Light	4C215-1-DV	\$89.95	4C215-1-AV	\$94.95
	Nurse, TV, 0-9 Keypad, 2 Lights	4C215-2-DV	\$91.95	4C215-2-AV	\$96.95
Gen4 Digital	Nurse, TV	4D215-0-DV	\$81.95	4D215-0-AV	\$86.95
	Nurse, TV, 1 Light	4D215-1-DV	\$83.95	4D215-1-AV	\$88.95
	Nurse, TV, 2 Lights	4D215-2-DV	\$85.95	4D215-2-AV	\$90.95
Gen III Analog	Nurse, TV	-	-	3808-002	\$69.00
	Nurse, TV, 1 Light	-	-	3808-021	\$71.00
	Nurse, TV, 2 Lights	-	-	3808-010	\$73.00

**NOTE:** CALL for complete Pillow Speaker part numbers.

Part numbers are based on standard wiring and 8 ft. cable length. Call for additional options including ear jack, alternate cable length, and auxiliaries.

**PILLOW SPEAKER REPAIR**

DESCRIPTION	PRICE
Repair of Gen4 DirectAccess, Gen4 Digital, Gen4 Interactive, or Gen III Analog	CALL

**PILLOW SPEAKER TESTER**

DESCRIPTION	MODEL #	PART #	PRICE
Tester with one module	CT-300	6333	\$395.95
Additional module for this nurse call system	CALL	CALL	\$85.95

**PILLOW SPEAKER REPLACEMENT CABLES**

DESCRIPTION	LENGTH	MODEL #	PART #	PRICE
Replacement Cable for Gen4 Pillow Speaker	8'	CAD-2100WC	CALL	\$26.16
Replacement Cable for Gen III Pillow Speaker	8'	CA3808	CALL	\$29.95

**CALL CORDS** (1/4" accessories may require an adaptor)

DESCRIPTION	LENGTH	8-PIN MODULAR MODEL #	PART #	PRICE	1/4" PLUG MODEL #	PART #	PRICE
Gen4 Sealed Call Cord	8'	SCC-2101-080-N	13272	\$21.95	SCC-0101-080-N	13259	\$16.95
Gen4 Sealed Call Cord	12'	-	-	-	SCC-0101-120-N	13261	\$18.95
Classic Call Cord	8'	CC96-080	5835	\$19.95	CC96-010	5822	\$14.95
Classic Call Cord	12'	-	-	-	CC144-010	5733	\$16.95
BreathCall	9'	GEB-170	7391	\$165.95	GEB-010	7380	\$136.95
E-Z Call	10'	-	-	-	GEE-010	7402	\$64.95
Mechanical Pad	10'	GEM-471	7430	\$47.95	GEM-0000-AGY	7407	\$43.95
PadCall	8'	GEA-145	7364	\$72.95	GEA-030	7351	\$50.95
PressCall	8'	GEP-310	7453	\$61.95	GEP-140	7441	\$39.95

**ADAPTORS** (see page 25 for descriptions of adaptor types)

TYPE	PLUG STYLE	RECEPTACLE 1	RECEPTACLE 2	RECEPTACLE 3	MODEL #	PART #	PRICE
Box	8-pin Modular	8-pin Modular	1/4" jack (nurse call)	-	ADP-0808-101	3322	\$77.95
Box	8-pin Modular	8-pin Modular	1/4" jack (nurse call)	1/4" jack (TV)	ADP-0808-102	3323	\$87.95
Box	8-pin Modular	8-pin Modular	8-pin Modular	-	ADP-0808-103	3324	\$91.95
Conversion	8-pin Modular	1/4" jack (nurse call)	-	-	AD-030	3212	\$30.95

**DUMMY PLUGS**

DESCRIPTION	MODEL #	PART #	PRICE
1/4" plug, Metal Plug, Overmolded, 6" Poly Cord	DP-020	6834	\$5.25
8-Pin Modular, 6" Poly Cord	DP-082	6844	\$8.95

**REPLACEMENT PILLOW SPEAKERS AND ACCESSORIES FOR:**

**Dukane® System 2000, 2010, 2020, 2030**

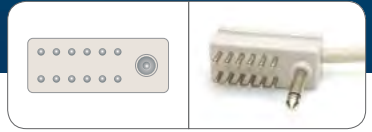

**PILLOW SPEAKERS**

TYPE	FEATURES	DIGITAL VOLUME MODEL #	PRICE	ANALOG VOLUME MODEL #	PRICE
Gen4 DirectAccess	Nurse, TV, 0-9 Keypad	4C110-0-DV	\$94.95	4C110-0-AV	\$99.95
	Nurse, TV, 0-9 Keypad, 1 Light	4C110-1-DV	\$96.95	4C110-1-AV	\$101.95
	Nurse, TV, 0-9 Keypad, 2 Lights	4C110-2-DV	\$98.95	4C110-2-AV	\$103.95
Gen4 Digital	Nurse, TV	4D110-0-DV	\$85.95	4D110-0-AV	\$90.95
	Nurse, TV, 1 Light	4D110-1-DV	\$87.95	4D110-1-AV	\$92.95
	Nurse, TV, 2 Lights	4D110-2-DV	\$89.95	4D110-2-AV	\$94.95
Gen III Analog	Nurse, TV	-	-	3413-001	\$78.40
	Nurse, TV, 1 Light	-	-	3413-002	\$80.50
	Nurse, TV, 2 Lights	-	-	3413-014	\$80.50

**NOTE:** CALL for complete Pillow Speaker part numbers.

Part numbers are based on standard wiring and 8 ft. cable length. Call for additional options including ear jack, alternate cable length, and auxiliaries.

**PILLOW SPEAKER REPAIR**

DESCRIPTION	PRICE
Repair of Gen4 DirectAccess, Gen4 Digital, Gen4 Interactive, or Gen III Analog	CALL

**PILLOW SPEAKER TESTER**

DESCRIPTION	MODEL #	PART #	PRICE
Tester with one module	CT-300	6333	\$395.95
Additional module for this nurse call system	CALL	CALL	\$86.95

**PILLOW SPEAKER REPLACEMENT CABLES**

DESCRIPTION	LENGTH	MODEL #	PART #	PRICE
Replacement Cable for Gen4 Pillow Speaker	8'	CAD-1100	CALL	\$31.16
Replacement Cable for Gen III Pillow Speaker	8'	CA3413	CALL	\$35.95

**CALL CORDS** (1/4" accessories may require an adaptor)

DESCRIPTION	LENGTH	MODEL #	PART #	PRICE
Gen4 Sealed Call Cord	8'	SCC-0101-080-N	13259	\$16.95
Gen4 Sealed Call Cord	12'	SCC-0101-120-N	13261	\$18.95
Classic Call Cord	8'	CC96-010	5822	\$14.95
Classic Call Cord	12'	CC144-010	5733	\$16.95
BreathCall	9'	GEB-010	7380	\$136.95
E-Z Call	10'	GEE-010	7402	\$64.95
Mechanical Pad	10'	GEM-0000-AGY	7407	\$43.95
PadCall	8'	GEA-030	7351	\$50.95
PressCall	8'	GEP-140	7441	\$39.95

**ADAPTORS** (see page 25 for descriptions of adaptor types)

TYPE	PLUG STYLE	RECEPTACLE 1	RECEPTACLE 2	RECEPTACLE 3	MODEL #	PART #	PRICE
Box	13-pin	13 Pin Dukane/GE	1/4" jack	-	ADP-0413-101	3271	\$87.95
Box	13-pin	13 Pin Dukane/GE	1/4" jack	1/4" (TV)	ADP-0413-106	3274	\$97.95

**DUMMY PLUGS**

DESCRIPTION	MODEL #	PART #	PRICE
1/4" plug, Metal Plug, Overmolded, 6" Poly Cord	DP-020	6834	\$5.25

**REPLACEMENT PILLOW SPEAKERS AND ACCESSORIES FOR:**

**Dukane® Procure 2000®, System 2070**



**PILLOW SPEAKERS**

TYPE	FEATURES	DIGITAL VOLUME MODEL #	PRICE	ANALOG VOLUME MODEL #	PRICE
Gen4 DirectAccess	Nurse, TV, 0-9 Keypad	4C120-0-DV	\$94.95	4C120-0-AV	\$99.95
	Nurse, TV, 0-9 Keypad, 1 Light	4C120-1-DV	\$96.95	4C120-1-AV	\$101.95
	Nurse, TV, 0-9 Keypad, 2 Lights	4C120-2-DV	\$98.95	4C120-2-AV	\$103.95
Gen4 Digital	Nurse, TV	4D120-0-DV	\$85.95	4D120-0-AV	\$90.95
	Nurse, TV, 1 Light	4D120-1-DV	\$87.95	4D120-1-AV	\$92.95
	Nurse, TV, 2 Lights	4D120-2-DV	\$89.95	4D120-2-AV	\$94.95
Gen III Analog	Nurse, TV	-	-	3417-002	\$84.70
	Nurse, TV, 1 Light	-	-	3417-306	\$86.80
	Nurse, TV, 2 Lights	-	-	3417-311	\$88.90
	Nurse, TV, 1 Light, Channel Up/Down	-	-	3417-013	\$90.70

**NOTE:** CALL for complete Pillow Speaker part numbers.

Part numbers are based on standard wiring and 8 ft. cable length. Call for additional options including ear jack, alternate cable length, and auxiliaries.

**PILLOW SPEAKER REPAIR**

DESCRIPTION	PRICE
Repair of Gen4 DirectAccess, Gen4 Digital, Gen4 Interactive, or Gen III Analog	CALL

**PILLOW SPEAKER TESTER**

DESCRIPTION	MODEL #	PART #	PRICE
Tester with one module	CT-300	6333	\$395.95
Additional module for this nurse call system	CALL	CALL	\$86.95

**PILLOW SPEAKER REPLACEMENT CABLES**

DESCRIPTION	LENGTH	MODEL #	PART #	PRICE
Replacement Cable for Gen4 Pillow Speaker	8'	CAD-1200	CALL	\$33.16
Replacement Cable for Gen III Pillow Speaker	8'	CA3417	CALL	\$40.95

**CALL CORDS** (1/4" accessories may require an adaptor)

DESCRIPTION	LENGTH	MODEL #	PART #	PRICE
Gen4 Sealed Call Cord	8'	SCC-0101-080-N	13259	\$16.95
Gen4 Sealed Call Cord	12'	SCC-0101-120-N	13261	\$18.95
Classic Call Cord	8'	CC96-010	5822	\$14.95
Classic Call Cord	12'	CC144-010	5733	\$16.95
BreathCall	9'	GEB-010	7380	\$136.95
E-Z Call	10'	GEE-010	7402	\$64.95
Mechanical Pad	10'	GEM-0000-AGY	7407	\$43.95
PadCall	8'	GEA-030	7351	\$50.95
PressCall	8'	GEP-140	7441	\$39.95

**ADAPTORS** (see page 25 for descriptions of adaptor types)

TYPE	PLUG STYLE	RECEPTACLE 1	RECEPTACLE 2	RECEPTACLE 3	MODEL #	PART #	PRICE
Box	17-pin	17 Pin Dukane/GE	1/4" jack	-	ADP-0417-104	3280	\$90.95
Box	17-pin	17 Pin Dukane/GE	1/4" jack	1/4" (TV)	ADP-0417-102	3279	\$100.95

**DUMMY PLUGS**

DESCRIPTION	MODEL #	PART #	PRICE
1/4" plug, Metal Plug, Overmolded, 6" Poly Cord	DP-020	6834	\$5.25

**REPLACEMENT PILLOW SPEAKERS AND ACCESSORIES FOR:**

**Dukane® Procure 2000®, System 2070**

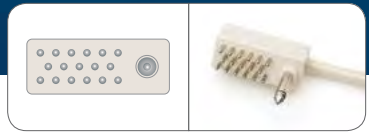

**PILLOW SPEAKERS**

TYPE	FEATURES	DIGITAL VOLUME MODEL #	PRICE	ANALOG VOLUME MODEL #	PRICE
Gen4 DirectAccess	Nurse, TV, 0-9 Keypad	4C130-0-DV	\$97.95	4C130-0-AV	\$102.95
	Nurse, TV, 0-9 Keypad, 1 Light	4C130-1-DV	\$99.95	4C130-1-AV	\$104.95
	Nurse, TV, 0-9 Keypad, 2 Lights	4C130-2-DV	\$101.95	4C130-2-AV	\$106.95
Gen4 Digital	Nurse, TV	4D130-0-DV	\$88.95	4D130-0-AV	\$93.95
	Nurse, TV, 1 Light	4D130-1-DV	\$90.95	4D130-1-AV	\$95.95
	Nurse, TV, 2 Lights	4D130-2-DV	\$92.95	4D130-2-AV	\$97.95
Gen III Analog	Nurse, TV	-	-	3419-002	\$87.85

**NOTE:** CALL for complete Pillow Speaker part numbers.

Part numbers are based on standard wiring and 8 ft. cable length. Call for additional options including ear jack, alternate cable length, and auxiliaries.

**PILLOW SPEAKER REPAIR**

DESCRIPTION	PRICE
Repair of Gen4 DirectAccess, Gen4 Digital, Gen4 Interactive, or Gen III Analog	CALL

**PILLOW SPEAKER TESTER**

DESCRIPTION	MODEL #	PART #	PRICE
Tester with one module	CT-300	6333	\$395.95
Additional module for this nurse call system	CALL	CALL	\$86.95

**PILLOW SPEAKER REPLACEMENT CABLES**

DESCRIPTION	LENGTH	MODEL #	PART #	PRICE
Replacement Cable for Gen4 Pillow Speaker	8'	CAD-1300	CALL	\$36.16
Replacement Cable for Gen III Pillow Speaker	8'	CA3419	CALL	\$43.95

**CALL CORDS** (1/4" accessories may require an adaptor)

DESCRIPTION	LENGTH	MODEL #	PART #	PRICE
Gen4 Sealed Call Cord	8'	SCC-0101-080-N	13259	\$16.95
Gen4 Sealed Call Cord	12'	SCC-0101-120-N	13261	\$18.95
Classic Call Cord	8'	CC96-010	5822	\$14.95
Classic Call Cord	12'	CC144-010	5733	\$16.95
BreathCall	9'	GEB-010	7380	\$136.95
E-Z Call	10'	GEE-010	7402	\$64.95
Mechanical Pad	10'	GEM-0000-AGY	7407	\$43.95
PadCall	8'	GEA-030	7351	\$50.95
PressCall	8'	GEP-140	7441	\$39.95

**ADAPTORS** (see page 25 for descriptions of adaptor types)

TYPE	PLUG STYLE	RECEPTACLE 1	RECEPTACLE 2	RECEPTACLE 3	MODEL #	PART #	PRICE
Box	19-pin	19 Pin Dukane/GE	1/4" jack	-	ADP-0419-102	3282	\$110.95

**DUMMY PLUGS**

DESCRIPTION	MODEL #	PART #	PRICE
1/4" plug, Metal Plug, Overmolded, 6" Poly Cord	DP-020	6834	\$5.25

**REPLACEMENT PILLOW SPEAKERS AND ACCESSORIES FOR:**

**Dukane® Procure 4000, 6000, System 2070**

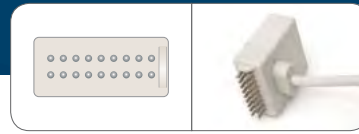

**PILLOW SPEAKERS**

TYPE	FEATURES	DIGITAL VOLUME MODEL #	PRICE	ANALOG VOLUME MODEL #	PRICE
Gen4 DirectAccess	Nurse, TV, 0-9 Keypad	4C320-0-DV	\$100.95	4C320-0-AV	\$105.95
	Nurse, TV, 0-9 Keypad, 1 Light	4C320-1-DV	\$102.95	4C320-1-AV	\$107.95
	Nurse, TV, 0-9 Keypad, 2 Lights	4C320-2-DV	\$104.95	4C320-2-AV	\$109.95
Gen4 Digital	Nurse, TV	4D320-0-DV	\$91.95	4D320-0-AV	\$96.95
	Nurse, TV, 1 Light	4D320-1-DV	\$93.95	4D320-1-AV	\$98.95
	Nurse, TV, 2 Lights	4D320-2-DV	\$95.95	4D320-2-AV	\$100.95
Gen III Analog	Nurse, TV	-	-	31801-001	\$83.65
	Nurse, TV, 1 Light	-	-	31801-002	\$85.75
	Nurse, TV, 2 Lights	-	-	31801-326	\$87.85

**NOTE:** CALL for complete Pillow Speaker part numbers.

Part numbers are based on standard wiring and 8 ft. cable length. Call for additional options including ear jack, alternate cable length, and auxiliaries.

**PILLOW SPEAKER REPAIR**

DESCRIPTION	PRICE
Repair of Gen4 DirectAccess, Gen4 Digital, Gen4 Interactive, or Gen III Analog	CALL

**PILLOW SPEAKER TESTER**

DESCRIPTION	MODEL #	PART #	PRICE
Tester with one module	CT-300	6333	\$395.95
Additional module for this nurse call system	CALL	CALL	\$96.95

**PILLOW SPEAKER REPLACEMENT CABLES**

DESCRIPTION	LENGTH	MODEL #	PART #	PRICE
Replacement Cable for Gen4 Pillow Speaker	8'	CAD-3200	CALL	\$38.16
Replacement Cable for Gen III Pillow Speaker	8'	CA31801	CALL	\$42.95

**CALL CORDS** (1/4" accessories may require an adaptor)

DESCRIPTION	LENGTH	18-PIN MODEL #	PART #	PRICE	1/4" PLUG MODEL #	PART #	PRICE
Gen4 Sealed Call Cord	8'	SCC-3701-820-U	13281	\$42.95	SCC-0101-080-U	13260	\$16.95
Gen4 Sealed Call Cord	12'	SCC-3701-C20-U	13283	\$46.95	SCC-0101-120-U	13262	\$18.95
Classic Call Cord	8'	-	-	-	CC96-010	5822	\$14.95
Classic Call Cord	12'	CC144-112	5742	\$44.95	CC144-010	5733	\$16.95
BreathCall	9'	-	-	-	GEB-010	7380	\$136.95
E-Z Call	10'	-	-	-	GEE-010	7402	\$64.95
Mechanical Pad	10'	GEM-477	7483	\$48.95	GEM-0000-AGY	7407	\$43.95
PadCall	8'	GEA-181	7369	\$72.95	GEA-030	7351	\$50.95
PressCall	8'	-	-	-	GEP-140	7441	\$39.95

**ADAPTORS** (see page 25 for descriptions of adaptor types)

TYPE	PLUG STYLE	RECEPTACLE 1	RECEPTACLE 2	RECEPTACLE 3	MODEL #	PART #	PRICE
Box	18-pin	18-Pin	1/4" jack	1/4" jack	ADP-1802-103	3354	\$121.95
Box	18-pin	18-Pin	18-Pin	1/4" (TV)	ADP-1802-104	3355	\$126.95
Conversion	18-pin	18-Pin	1/4" (TV)	-	AD-185	3241	\$19.95

**DUMMY PLUGS**

DESCRIPTION	MODEL #	PART #	PRICE
1/4" plug, Metal Plug, Overmolded, 6" Poly Cord	DP-020	6834	\$5.25

**REPLACEMENT PILLOW SPEAKERS AND ACCESSORIES FOR:**

**Executone® Care/Com**

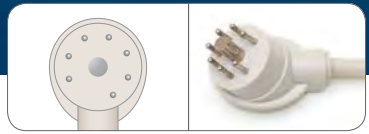

**PILLOW SPEAKERS**

TYPE	FEATURES	DIGITAL VOLUME MODEL #	PRICE	ANALOG VOLUME MODEL #	PRICE
Gen4 DirectAccess	Nurse, TV, 0-9 Keypad	4C050-0-DV	\$87.95	4C050-0-AV	\$92.95
	Nurse, TV, 0-9 Keypad, 1 Light	4C050-1-DV	\$89.95	4C050-1-AV	\$95.95
Gen4 Digital	Nurse, TV	4D050-0-DV	\$76.95	4D050-0-AV	\$81.95
	Nurse, TV, 1 Light	4D050-1-DV	\$78.95	4D050-1-AV	\$83.95
Gen III Analog	Nurse, TV	-	-	3307-001	\$64.75
	Nurse, TV, 1 Light	-	-	3307-002	\$66.85
	Nurse, TV, Radio	-	-	3307-003	\$66.85

**NOTE:** CALL for complete Pillow Speaker part numbers.

Part numbers are based on standard wiring and 8 ft. cable length. Call for additional options including ear jack, alternate cable length, and auxiliaries.

**PILLOW SPEAKER REPAIR**

DESCRIPTION	PRICE
Repair of Gen4 DirectAccess, Gen4 Digital, Gen4 Interactive, or Gen III Analog	CALL

**PILLOW SPEAKER TESTER**

DESCRIPTION	MODEL #	PART #	PRICE
Tester with one module	CT-300	6333	\$395.95
Additional module for this nurse call system	CALL	CALL	\$88.95

**PILLOW SPEAKER REPLACEMENT CABLES**

DESCRIPTION	LENGTH	MODEL #	PART #	PRICE
Replacement Cable for Gen4 Pillow Speaker	8'	CAD-0500	CALL	\$24.16
Replacement Cable for Gen III Pillow Speaker	8'	CA3307	CALL	\$27.95

**CALL CORDS** (1/4" accessories may require an adaptor)

DESCRIPTION	LENGTH	MODEL #	PART #	PRICE
Gen4 Sealed Call Cord	8'	SCC-0101-080-U	13260	\$16.95
Gen4 Sealed Call Cord	12'	SCC-0101-120-U	13262	\$18.95
Classic Call Cord	8'	CC96-010	5822	\$14.95
Classic Call Cord	12'	CC144-010	5733	\$16.95
BreathCall	9'	GEB-010	7380	\$136.95
E-Z Call	10'	GEE-010	7402	\$64.95
Mechanical Pad	10'	GEM-0000-AGY	7407	\$43.95
PadCall	8'	GEA-030	7351	\$50.95
PressCall	8'	GEP-140	7441	\$39.95

**ADAPTORS** (see page 25 for descriptions of adaptor types)

TYPE	PLUG STYLE	RECEPTACLE 1	RECEPTACLE 2	RECEPTACLE 3	MODEL #	PART #	PRICE
Box	7-pin	7-pin	7-pin	-	ADP-0307-106	3251	\$100.95
Box	7-pin	7-pin	1/4" jack	-	ADP-0307-103	3248	\$76.95
Box	7-pin	7-pin	1/4" jack	1/4" jack	ADP-0307-109	3253	\$86.95

**DUMMY PLUGS**

DESCRIPTION	MODEL #	PART #	PRICE
1/4" plug, Metal Plug, Overmolded, 6" Poly Cord	DP-020	6834	\$5.25

**REPLACEMENT PILLOW SPEAKERS AND ACCESSORIES FOR:**

**Executone® Futura**

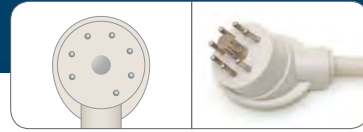

**PILLOW SPEAKERS**

TYPE	FEATURES	DIGITAL VOLUME MODEL #	PRICE	ANALOG VOLUME MODEL #	PRICE
Gen4 DirectAccess	Nurse, TV, 0-9 Keypad	4C055-0-DV	\$87.95	4C055-0-AV	\$92.95
	Nurse, TV, 0-9 Keypad, 1 Light	4C055-1-DV	\$89.95	4C055-1-AV	\$94.95
Gen4 Digital	Nurse, TV	4D055-0-DV	\$76.95	4D055-0-AV	\$81.95
	Nurse, TV, 1 Light	4D055-1-DV	\$78.95	4D055-1-AV	\$83.95
Gen III Analog	Nurse, TV	-	-	3307SA-001	\$64.75
	Nurse, TV, 1 Light	-	-	3307SA-002	\$66.85

**NOTE:** CALL for complete Pillow Speaker part numbers. Part numbers are based on standard wiring and 8 ft. cable length. Call for additional options including ear jack, alternate cable length, and auxiliaries.

**PILLOW SPEAKER REPAIR**

DESCRIPTION	PRICE
Repair of Gen4 DirectAccess, Gen4 Digital, Gen4 Interactive, or Gen III Analog	CALL

**PILLOW SPEAKER TESTER**

DESCRIPTION	MODEL #	PART #	PRICE
Tester with one module	CT-300	6333	\$395.95
Additional module for this nurse call system	CALL	CALL	\$88.95

**PILLOW SPEAKER REPLACEMENT CABLES**

DESCRIPTION	LENGTH	MODEL #	PART #	PRICE
Replacement Cable for Gen4 Pillow Speaker	8'	CAD-0500	CALL	\$24.16
Replacement Cable for Gen III Pillow Speaker	8'	CA3307	CALL	\$27.95

**CALL CORDS** (1/4" accessories may require an adaptor)

DESCRIPTION	LENGTH	MODEL #	PART #	PRICE
Gen4 Sealed Call Cord	8'	SCC-0101-080-U	13260	\$16.95
Gen4 Sealed Call Cord	12'	SCC-0101-120-U	13262	\$18.95
Classic Call Cord	8'	CC96-010	5822	\$14.95
Classic Call Cord	12'	CC144-010	5733	\$16.95
BreathCall	9'	GEB-010	7380	\$136.95
E-Z Call	10'	GEE-010	7402	\$64.95
Mechanical Pad	10'	GEM-0000-AGY	7407	\$43.95
PadCall	8'	GEA-030	7351	\$50.95
PressCall	8'	GEP-140	7441	\$39.95

**ADAPTORS** (see page 25 for descriptions of adaptor types)

TYPE	PLUG STYLE	RECEPTACLE 1	RECEPTACLE 2	RECEPTACLE 3	MODEL #	PART #	PRICE
Box	7-pin Futura	7-pin Futura	1/4" jack	-	ADP-0307-111	14299	\$100.95
Box	7-pin Futura	7-pin Futura	1/4" jack	1/4" (TV)	ADP-0307-112	3254	\$76.95
Box	7-pin Futura	7-pin Futura	7-pin Futura	-	ADP-0307-113	3255	\$86.95

**DUMMY PLUGS**

DESCRIPTION	MODEL #	PART #	PRICE
1/4" plug, Metal Plug, Overmolded, 6" Poly Cord	DP-020	6834	\$5.25

**REPLACEMENT PILLOW SPEAKERS AND ACCESSORIES FOR:**

**Executone® Lifesaver®**

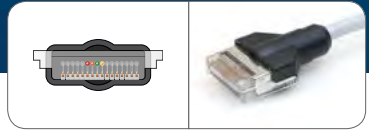

**PILLOW SPEAKERS**

TYPE	FEATURES	DIGITAL VOLUME MODEL #	PRICE	ANALOG VOLUME MODEL #	PRICE
Gen4 DirectAccess	Nurse, TV, 0-9 Keypad	4C310-0-DV	\$115.95	4C310-0-AV	\$118.95
	Nurse, TV, 0-9 Keypad, 1 Light	4C310-1-DV	\$104.95	4C310-1-AV	\$120.95
Gen4 Digital	Nurse, TV	4D310-0-DV	\$106.95	4D310-0-AV	\$109.95
	Nurse, TV, 1 Light	4D310-1-DV	\$78.95	4D310-1-AV	\$111.95
Gen III Analog	Nurse, TV	-	-	31602-011	\$104.95
	Nurse, TV, 1 Light	-	-	31602-012	\$108.95

**NOTE:** CALL for complete Pillow Speaker part numbers. Part numbers are based on standard wiring and 8 ft. cable length. Call for additional options including ear jack, alternate cable length, and auxiliaries.

**PILLOW SPEAKER REPAIR**

DESCRIPTION	PRICE
Repair of Gen4 DirectAccess, Gen4 Digital, Gen4 Interactive, or Gen III Analog	CALL

**PILLOW SPEAKER TESTER**

DESCRIPTION	MODEL #	PART #	PRICE
Tester with one module	CT-300	6333	\$395.95
Additional module for this nurse call system	CALL	CALL	\$90.95

**PILLOW SPEAKER REPLACEMENT CABLES**

DESCRIPTION	LENGTH	MODEL #	PART #	PRICE
Replacement Cable for Gen4 Pillow Speaker	8'	CAD-3100	CALL	\$52.16
Replacement Cable for Gen III Pillow Speaker	8'	CA31602	CALL	\$56.95

**NOTE:** Cables on all Lifesaver products are configured to E-Key style.

**BED TO NURSE CALL CABLES**

If you need to interface your beds with your Nurse Call system, Curbell can meet your specific wiring needs for the hundreds of possible configurations.

- Available for most beds, including those from Amico, ArjoHuntleigh®, Carroll® (CHG®), Hill-Rom®, Joerns, Kreg Medical, Linet®, Next Health, Rotec, Sizewise, Stryker®, Stryker London, and Umamo Medical
- Inline or 90° 37-Pin connectors
- For all common Nurse Call systems (see chart below)
- 8' standard length, other lengths available
- One year warranty



SEE PAGE 41 FOR ALL THE AVAILABLE PLUG STYLES



**REPLACEMENT PILLOW SPEAKERS AND ACCESSORIES FOR:**

**Fisher Berkeley HP Series, MMC Series**



**PILLOW SPEAKERS**

TYPE	FEATURES	DIGITAL VOLUME MODEL #	PRICE	ANALOG VOLUME MODEL #	PRICE
Gen4 DirectAccess	Nurse, TV, 0-9 Keypad	4C300-0-DV	\$95.95	4C300-0-AV	\$100.95
	Nurse, TV, 0-9 Keypad, 1 Light	4C300-1-DV	\$97.95	4C300-1-AV	\$102.95
	Nurse, TV, 0-9 Keypad, 2 Lights	4C300-2-DV	\$99.95	4C300-2-AV	\$104.95
Gen4 Digital	Nurse, TV	4D300-0-DV	\$88.95	4D300-0-AV	\$93.95
	Nurse, TV, 1 Light	4D300-1-DV	\$90.95	4D300-1-AV	\$95.95
	Nurse, TV, 2 Lights	4D300-2-DV	\$92.95	4D300-2-AV	\$97.95
Gen III Analog	Nurse, TV	-	-	31505-010	\$77.35
	Nurse, TV, 1 Light	-	-	31505-004	\$82.60

**NOTE:** CALL for complete Pillow Speaker part numbers.

Part numbers are based on standard wiring and 8 ft. cable length. Call for additional options including ear jack, alternate cable length, and auxiliaries.

**PILLOW SPEAKER REPAIR**

DESCRIPTION	PRICE
Repair of Gen4 DirectAccess, Gen4 Digital, or Gen4 Interactive	CALL

**PILLOW SPEAKER TESTER**

DESCRIPTION	MODEL #	PART #	PRICE
Tester with one module	CT-300	6333	\$395.95
Additional module for this nurse call system	CALL	CALL	\$86.95

**PILLOW SPEAKER REPLACEMENT CABLES**

DESCRIPTION	LENGTH	MODEL #	PART #	PRICE
Replacement Cable for Gen4 Pillow Speaker	8'	CAD-3000	CALL	\$38.16
Replacement Cable for Gen III Pillow Speaker	8'	CA31505	CALL	\$41.95

**CALL CORDS** (1/4" accessories may require an adaptor)

DESCRIPTION	LENGTH	15-PIN MODEL #	PART #	PRICE	1/4" PLUG MODEL #	PART #	PRICE
Gen4 Sealed Call Cord	8'	-	-	-	SCC-0101-080-N	13259	\$16.95
Gen4 Sealed Call Cord	12'	-	-	-	SCC-0101-120-N	13261	\$18.95
Classic Call Cord	8'	CC96-985	5875	\$36.95	CC96-010	5822	\$14.95
Classic Call Cord	12'	-	-	-	CC144-010	5733	\$16.95
BreathCall	9'	GEB-070	7384	\$177.95	GEB-010	7380	\$136.95
E-Z Call	10'	-	-	-	GEE-010	7402	\$64.95
Mechanical Pad	10'	GEM-070	7416	\$52.95	GEM-0000-AGY	7407	\$43.95
PadCall	8'	GEA-100	7356	\$89.95	GEA-030	7351	\$50.95
PressCall	8'	GEP-200	7444	\$77.95	GEP-140	7441	\$39.95

**DUMMY PLUGS**

DESCRIPTION	MODEL #	PART #	PRICE
1/4" plug, Metal Plug, Overmolded, 6" Poly Cord	DP-020	6384	\$5.25
15-Pin, 6" Poly cord	DP-040	6836	\$12.95

**REPLACEMENT PILLOW SPEAKERS AND ACCESSORIES FOR:**

**HCE/Sylvania® (All Systems)**

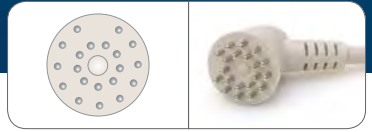

**PILLOW SPEAKERS**

TYPE	FEATURES	DIGITAL VOLUME MODEL #	PRICE	ANALOG VOLUME MODEL #	PRICE
Gen4 DirectAccess	Nurse, TV, 0-9 Keypad	4C080-0-DV	\$97.95	4C080-0-AV	\$102.95
	Nurse, TV, 0-9 Keypad, 1 Light	4C080-1-DV	\$99.95	4C080-1-AV	\$104.95
	Nurse, TV, 0-9 Keypad, 2 Lights	4C080-2-DV	\$101.95	4C080-2-AV	\$104.95
Gen4 Digital	Nurse, TV	4D080-0-DV	\$87.95	4D080-0-AV	\$92.95
	Nurse, TV, 1 Light	4D080-1-DV	\$89.95	4D080-1-AV	\$94.95
	Nurse, TV, 2 Lights	4D080-2-DV	\$91.95	4D080-2-AV	\$96.95
Gen III Analog	Nurse, TV	-	-	3320-001	\$73.15
	Nurse, TV, 1 Light	-	-	3320-013	\$75.25
	Nurse, TV, 2 Lights	-	-	3320-015	\$77.35

**NOTE:** CALL for complete Pillow Speaker part numbers.

Part numbers are based on standard wiring and 8 ft. cable length. Call for additional options including ear jack, alternate cable length, and auxiliaries.

**PILLOW SPEAKER REPAIR**

DESCRIPTION	PRICE
Repair of Gen4 DirectAccess, Gen4 Digital, Gen4 Interactive, or Gen III Analog	CALL

**PILLOW SPEAKER TESTER**

DESCRIPTION	MODEL #	PART #	PRICE
Tester with one module	CT-300	6333	\$395.95
Additional module for this nurse call system	CALL	CALL	\$96.95

**PILLOW SPEAKER REPLACEMENT CABLES**

DESCRIPTION	LENGTH	MODEL #	PART #	PRICE
Replacement Cable for Gen4 Pillow Speaker	8'	CAD-0801	CALL	\$36.16
Replacement Cable for Gen III Pillow Speaker	8'	CA3320	CALL	\$39.16

**CALL CORDS**

DESCRIPTION	LENGTH	20-PIN PLUG MODEL #	PART #	PRICE
Classic Call Cord	8'	CC96-160	5840	\$32.95
BreathCall	9'	GEB-110	7385	\$147.95
Mechanical Pad	10'	GEM-472	7431	\$48.95
PadCall	8'	GEA-110	14650	\$75.95
PressCall	8'	GEP-220	14270	\$61.95

**ADAPTORS** (see page 25 for descriptions of adaptor types)

TYPE	PLUG STYLE	RECEPTACLE 1	RECEPTACLE 2	RECEPTACLE 3	MODEL #	PART #	PRICE
Box	20-pin	1/4" jack	1/4" jack	-	ADP-0320F-104	3263	\$96.95
Box	20-pin	20-pin	20-pin	-	ADP-0320F-105	3264	\$100.95

**REPLACEMENT PILLOW SPEAKERS AND ACCESSORIES FOR:**

**Hill-Rom® COMLinx®, COMposer®, and NaviCare®**

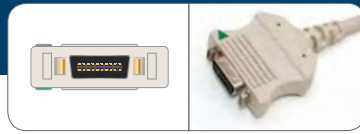

**PILLOW SPEAKERS**

TYPE	FEATURES	DIGITAL VOLUME MODEL #	PRICE	ANALOG VOLUME MODEL #	PRICE
Gen4 DirectAccess	Nurse, TV, 0-9 Keypad	4C330-0-DV	\$102.95	4C330-0-AV	\$107.95
	Nurse, TV, 0-9 Keypad, 1 Light	4C330-1-DV	\$104.95	4C330-1-AV	\$109.95
	Nurse, TV, 0-9 Keypad, 2 Lights	4C330-2-DV	\$106.95	4C330-2-AV	\$111.95
	Nurse, TV, 0-9 Keypad, Microphone	4C331-0-DV	\$126.95	4C331-0-AV	\$131.95
	Nurse, TV, 0-9 Keypad, 1 Light, Microphone	4C331-1-DV	\$128.95	4C331-1-AV	\$133.95
	Nurse, TV, 0-9 Keypad, 2 Lights, Microphone	4C331-2-DV	\$130.95	4C331-2-AV	\$135.95
	Nurse, TV, 0-9 Keypad, Microphone, Pain/Toilet	4C331-PT-DV	\$136.95	4C331-PT-AV	\$141.95
	Nurse, TV, 0-9 Keypad, 1 Light, Microphone, Pain/Toilet	4C331-3-DV	\$138.95	4C331-3-AV	\$143.95
Gen4 Digital	Nurse, TV, 0-9 Keypad, 2 Lights, Microphone, Pain/Toilet	4C331-4-DV	\$140.95	4C331-4-AV	\$145.95
	Nurse, TV	4D330-0-DV	\$98.95	4D330-0-AV	\$103.95
	Nurse, TV, 1 Light	4D330-1-DV	\$100.95	4D330-1-AV	\$105.95
	Nurse, TV, 2 Lights	4D330-2-DV	\$102.95	4D330-2-AV	\$107.95
	Nurse, TV, Microphone	4D331-0-DV	\$121.95	4D331-0-AV	\$126.95
	Nurse, TV, 1 Light, Microphone	4D331-1-DV	\$123.95	4D331-1-AV	\$128.95
	Nurse, TV, 2 Lights, Microphone	4D331-2-DV	\$125.95	4D331-2-AV	\$130.95
	Nurse, TV, Microphone, Pain/Toilet	4D331-PT-DV	\$131.95	4D331-PT-AV	\$136.95
Gen III Analog	Nurse, TV, 1 Light, Microphone, Pain/Toilet	4D331-3-DV	\$133.95	4D331-3-AV	\$138.95
	Nurse, TV, 2 Lights, Microphone, Pain/Toilet	4D331-4-DV	\$135.95	4D331-4-AV	\$140.95
	Nurse, TV	-	-	32020-006	\$100.45
	Nurse, TV, 1 Light	-	-	32020-008	\$104.65

**NOTE:** CALL for complete Pillow Speaker part numbers.

Part numbers are based on standard wiring and 8 ft. cable length. Call for additional options including ear jack, alternate cable length, and auxiliaries.

**PILLOW SPEAKER REPAIR**

DESCRIPTION	PRICE
Repair of Gen4 DirectAccess, Gen4 Digital, or Gen4 Interactive	CALL

**PILLOW SPEAKER TESTER** (May not test all functions of every model — call for details)

DESCRIPTION	MODEL #	PART #	PRICE
Tester with one module	CT-300	6333	\$395.95
Additional module for this nurse call system	CALL	CALL	\$129.95

**PILLOW SPEAKER REPLACEMENT CABLES**

DESCRIPTION	LENGTH	MODEL #	PART #	PRICE
Replacement Cable for Gen4 Pillow Speaker	8'	CAD-3300	CALL	\$44.16
Replacement Cable for Gen III Pillow Speaker	8'	CA32020	CALL	\$54.95

**CALL CORDS** (1/4" accessories may require an adaptor)

DESCRIPTION	LENGTH	20-PIN MODEL #	PART #	PRICE	1/4" PLUG MODEL #	PART #	PRICE
Gen4 Sealed Call Cord	8'	-	-	-	SCC-0101-080-U	13260	\$16.95
Gen4 Sealed Call Cord	12'	-	-	-	SCC-0101-120-U	13262	\$18.95
Classic Call Cord	8'	-	-	-	CC96-010	5822	\$14.95
Classic Call Cord	12'	-	-	-	CC144-010	5733	\$16.95
BreathCall	9'	-	-	-	GEB-010	7380	\$136.95
E-Z Call	10'	-	-	-	GEE-010	7402	\$64.95
Mechanical Pad	10'	GEM-035	7415	\$72.95	GEM-0000-AGY	7407	\$43.95
PadCall	8'	-	-	-	GEA-030	7351	\$50.95
PressCall	8'	-	-	-	GEP-140	7441	\$39.95

**ADAPTORS** (see page 25 for descriptions of adaptor types)

TYPE	PLUG STYLE	RECEPTACLE 1	RECEPTACLE 2	RECEPTACLE 3	MODEL #	PART #	PRICE
Box	20-pin	20-pin	1/4" jack (nurse)	-	ADP-2020-101	3367	\$140.95
Box	20-pin	20-pin	1/4" jack (nurse)	1/4" jack (TV)	ADP-2020-102	3368	\$150.95

**DUMMY PLUGS**

DESCRIPTION	MODEL #	PART #	PRICE
1/4" plug, Metal Plug, Overmolded, 6" Poly Cord	DP-020	6384	\$5.25

**REPLACEMENT PILLOW SPEAKERS AND ACCESSORIES FOR:**

**Hill-Rom® DB37, Headwall**

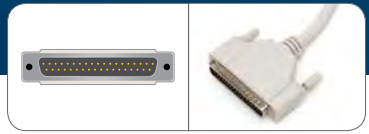

**PILLOW SPEAKERS**

TYPE	FEATURES	DIGITAL VOLUME MODEL #	PRICE	ANALOG VOLUME MODEL #	PRICE
Gen4 DirectAccess	Nurse, TV, 0-9 Keypad	4C360-0-DV	\$98.95	4C360-0-AV	\$103.95
	Nurse, TV, 0-9 Keypad, 1 Light	4C360-1-DV	\$100.95	4C360-1-AV	\$105.95
	Nurse, TV, 0-9 Keypad, 2 Lights	4C360-2-DV	\$102.95	4C360-2-AV	\$107.95
Gen4 Digital	Nurse, TV	4D360-0-DV	\$95.95	4D360-0-AV	\$100.95
	Nurse, TV, 1 Light	4D360-1-DV	\$94.95	4D360-1-AV	\$102.95
	Nurse, TV, 2 Lights	4D360-2-DV	\$96.95	4D360-2-AV	\$104.95
Gen III Analog	Nurse, TV	-	-	33701-042	\$96.25
	Nurse, TV, 1 Light	-	-	33701-064	\$98.35
	Nurse, TV, 2 Lights	-	-	33701-001	\$100.45

**NOTE:** CALL for complete Pillow Speaker part numbers.

Part numbers are based on standard wiring and 8 ft. cable length. Call for additional options including ear jack, alternate cable length, and auxiliaries.

**PILLOW SPEAKER REPAIR**

DESCRIPTION	PRICE
Repair of Gen4 DirectAccess, Gen4 Digital, Gen4 Interactive, or Gen III Analog	CALL

**PILLOW SPEAKER TESTER**

DESCRIPTION	MODEL #	PART #	PRICE
Tester with one module	CT-300	6333	\$395.95
Additional module for this nurse call system	CALL	CALL	\$92.95

**PILLOW SPEAKER REPLACEMENT CABLES**

DESCRIPTION	LENGTH	MODEL #	PART #	PRICE
Replacement Cable for Gen4 Pillow Speaker	8'	CAD-3600	CALL	\$45.16
Replacement Cable for Gen III Pillow Speaker	8'	CA33701	CALL	\$56.95

**CALL CORDS** (1/4" accessories may require an adaptor)

DESCRIPTION	LENGTH	37-PIN MODEL #	PART #	PRICE	1/4" PLUG MODEL #	PART #	PRICE
Gen4 Sealed Call Cord	8'	-	-	-	SCC-0101-080-N	13259	\$16.95
Gen4 Sealed Call Cord	12'	-	-	-	SCC-0101-120-N	13261	\$18.95
Classic Call Cord	8'	-	-	-	CC96-010	5822	\$14.95
Classic Call Cord	12'	-	-	-	CC144-010	5733	\$16.95
BreathCall	9'	-	-	-	GEB-010	7380	\$136.95
E-Z Call	10'	-	-	-	GEE-010	7402	\$64.95
Mechanical Pad	10'	GEM-150	7420	\$57.95	GEM-0000-AGY	7407	\$43.95
PadCall	8'	-	-	-	GEA-030	7351	\$50.95
PressCall	8'	-	-	-	GEP-140	7441	\$39.95

**ADAPTORS** (see page 25 for descriptions of adaptor types)

TYPE	PLUG STYLE	RECEPTACLE 1	RECEPTACLE 2	RECEPTACLE 3	MODEL #	PART #	PRICE
Box	37-pin	37-pin	1/4" jack (nurse call)	1/4" jack (TV)	ADP-3703-104	16661	\$114.95
Box	37-pin	7-pin	1/4" jack (nurse call)	-	ADP-3703-101	16659	\$103.95
Conversion	37-pin	1/4" jack (bed exit)	-	-	AD-155	3237	\$21.95

**DUMMY PLUGS**

DESCRIPTION	MODEL #	PART #	PRICE
37-pin, 6" Poly Cord (Jump 7 and 25, 10 and 11)	DP-100	6846	\$11.95
37-pin, 6" Poly Cord (Jump 7 and 25, 8 and 9, 10 and 11)	DP-110	6849	\$12.95



**REPLACEMENT PILLOW SPEAKERS AND ACCESSORIES FOR:**

**Intercall® Legend II, Equinox II, Spectrum II, Ultra 6000, 6900, 9000**



**PILLOW SPEAKERS**

TYPE	FEATURES	DIGITAL VOLUME MODEL #	PRICE	ANALOG VOLUME MODEL #	PRICE
Gen4 DirectAccess	Nurse, TV, 0-9 Keypad	4C19D-0-DV	\$97.95	4C19D-0-AV	\$102.95
	Nurse, TV, 0-9 Keypad, 1 Light	4C19D-1-DV	\$99.95	4C19D-1-AV	\$104.95
	Nurse, TV, 0-9 Keypad, 2 Lights	4C19D-2-DV	\$101.95	4C19D-2-AV	\$106.95
Gen4 Digital	Nurse, TV	4D19D-0-DV	\$84.95	4D19D-0-AV	\$89.95
	Nurse, TV, 1 Light	4D19D-1-DV	\$86.95	4D19D-1-AV	\$91.95
	Nurse, TV, 2 Lights	4D19D-2-DV	\$88.95	4D19D-2-AV	\$93.95
Gen III Analog	Nurse, TV	-	-	3800-317	\$75.25
	Nurse, TV, 2 Lights	-	-	3800-565	\$77.35

**NOTE:** CALL for complete Pillow Speaker part numbers.

Part numbers are based on standard wiring and 8 ft. cable length. Call for additional options including ear jack, alternate cable length, and auxiliaries.

**PILLOW SPEAKER REPAIR**

DESCRIPTION	PRICE
Repair of Gen4 DirectAccess, Gen4 Digital, Gen4 Interactive, or Gen III Analog	CALL

**PILLOW SPEAKER TESTER**

DESCRIPTION	MODEL #	PART #	PRICE
Tester with one module	CT-300	6333	\$395.95
Additional module for this nurse call system	CALL	CALL	\$75.95

**PILLOW SPEAKER REPLACEMENT CABLES**

DESCRIPTION	LENGTH	MODEL #	PART #	PRICE
Replacement Cable for Gen4 Pillow Speaker	8'	CAD-1900I	CALL	\$28.16
Replacement Cable for Gen III Pillow Speaker	8'	CA3800I	CALL	\$32.95

**CALL CORDS** (1/4" accessories may require an adaptor)

DESCRIPTION	LENGTH	8-PIN DIN MODEL #	PART #	PRICE	1/4" PLUG MODEL #	PART #	PRICE
Gen4 Sealed Call Cord	8'	-	-	-	SCC-0101-080-U	13260	\$16.95
Gen4 Sealed Call Cord	12'	-	-	-	SCC-0101-120-U	13262	\$18.95
Classic Call Cord	8'	-	-	-	CC96-010	5822	\$14.95
Classic Call Cord	12'	-	-	-	CC144-010	5733	\$16.95
BreathCall	9'	GEB-157	7389	\$165.95	GEB-010	7380	\$136.95
E-Z Call	10'	-	-	-	GEE-010	7402	\$64.95
Mechanical Pad	10'	GEM-300	7425	\$47.95	GEM-0000-AGY	7407	\$43.95
PadCall	8'	GEA-138	7361	\$72.95	GEA-030	7351	\$50.95
PressCall	8'	GEP-565	7466	\$61.95	GEP-140	7441	\$39.95

**ADAPTORS** (see page 25 for descriptions of adaptor types)

TYPE	PLUG STYLE	RECEPTACLE 1	RECEPTACLE 2	RECEPTACLE 3	MODEL #	PART #	PRICE
Box	8-pin DIN	8-pin DIN	1/4" jack (nurse call)	-	ADP-0800-105	3286	\$79.95
Box	8-pin DIN	8-pin DIN	1/4" jack (nurse call)	1/4" jack (TV)	ADP-0800-107	3288	\$89.95

**DUMMY PLUGS**

DESCRIPTION	MODEL #	PART #	PRICE
8-Pin DIN, 6" cord	DPG-1900-001	6875	\$9.95
1/4" plug, Metal Plug, Overmolded, 6" Poly Cord	DP-020	6834	\$5.25

**REPLACEMENT PILLOW SPEAKERS AND ACCESSORIES FOR:**

**Jeron® Pro-Alert™ 640, Provider® 680, Spectrum® Pro IR**



**PILLOW SPEAKERS**

TYPE	FEATURES	DIGITAL VOLUME MODEL #	PRICE	ANALOG VOLUME MODEL #	PRICE
Gen4 DirectAccess	Nurse, TV, 0-9 Keypad	4C19C-0-DV	\$97.95	4C19C-0-AV	\$102.95
	Nurse, TV, 0-9 Keypad, 1 Light	4C19C-1-DV	\$99.95	4C19C-1-AV	\$104.95
	Nurse, TV, 0-9 Keypad, 2 Lights	4C19C-2-DV	\$101.95	4C19C-2-AV	\$106.95
Gen4 Digital	Nurse, TV	4D19C-0-DV	\$84.95	4D19C-0-AV	\$89.95
	Nurse, TV, 1 Light	4D19C-1-DV	\$86.95	4D19C-1-AV	\$91.95
	Nurse, TV, 2 Lights	4D19C-2-DV	\$88.95	4D19C-2-AV	\$93.95
Gen III Analog	Nurse, TV	-	-	3800-016	\$46.45
	Nurse, TV, 2 Lights	-	-	3800-022	\$47.78

**NOTE:** CALL for complete Pillow Speaker part numbers.

Part numbers are based on standard wiring and 8 ft. cable length. Call for additional options including ear jack, alternate cable length, and auxiliaries.

**PILLOW SPEAKER REPAIR**

DESCRIPTION	PRICE
Repair of Gen4 DirectAccess, Gen4 Digital, Gen4 Interactive, or Gen III Analog	CALL

**PILLOW SPEAKER TESTER**

DESCRIPTION	MODEL #	PART #	PRICE
Tester with one module	CT-300	6333	\$395.95
Additional module for this nurse call system	CALL	CALL	\$75.95

**PILLOW SPEAKER REPLACEMENT CABLES**

DESCRIPTION	LENGTH	MODEL #	PART #	PRICE
Replacement Cable for Gen4 Pillow Speaker	8'	CAD-1900J	CALL	\$28.16
Replacement Cable for Gen III Pillow Speaker	8'	CA3800J	CALL	\$32.95

**CALL CORDS** (1/4" accessories may require an adaptor)

DESCRIPTION	LENGTH	8-PIN DIN MODEL #	PART #	PRICE	1/4" PLUG MODEL #	PART #	PRICE
Gen4 Sealed Call Cord	8'	SCC-1901-081-U	13268	\$26.95	SCC-0101-080-N	13259	\$16.95
Gen4 Sealed Call Cord	12'	-	-	-	SCC-0101-120-N	13261	\$18.95
Classic Call Cord	8'	CC96-300	5851	\$24.95	CC96-010	5822	\$14.95
Classic Call Cord	12'	CC144-466	5755	\$28.95	CC144-010	5733	\$16.95
BreathCall	9'	GEB-155	7388	\$165.95	GEB-010	7380	\$136.95
E-Z Call	10'	-	-	-	GEE-010	7402	\$64.95
Mechanical Pad	10'	GEM-180	7423	\$47.95	GEM-0000-AGY	7407	\$43.95
PadCall	8'	GEA-135	7359	\$72.95	GEA-030	7351	\$50.95
PressCall	8'	GEP-265	7450	\$61.95	GEP-140	7441	\$39.95

**ADAPTORS** (see page 25 for descriptions of adaptor types)

TYPE	PLUG STYLE	RECEPTACLE 1	RECEPTACLE 2	RECEPTACLE 3	MODEL #	PART #	PRICE
Box	8-pin DIN	8-pin DIN	1/4" jack (nurse call)	-	ADP-0800-101	3283	\$79.95
Conversion	8-pin DIN	8-pin DIN	1/4" jack (nurse call)	-	AD-110	3233	\$29.95
Jumper	8-pin DIN	8-pin DIN	8-pin DIN	1/4" jack (nurse call)	JUP-1101-002	18194	\$52.95
Jumper	8-pin DIN	8-pin DIN	1/4" jack (nurse call)	-	JUP-1055-101-002	8513	\$18.95

**DUMMY PLUGS**

DESCRIPTION	MODEL #	PART #	PRICE
1/4" plug, Metal Plug, Overmolded, 6" Poly Cord	DP-020	6834	\$5.25
8-Pin DIN, no cord	DP-062	6840	\$8.95
8-Pin DIN, 6" Poly Cord	DP-066	6842	\$10.95

**REPLACEMENT PILLOW SPEAKERS AND ACCESSORIES FOR:**

**Jeron® 680+**

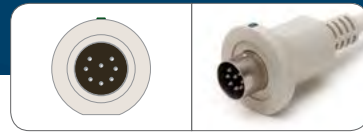

**PILLOW SPEAKERS**

TYPE	FEATURES	DIGITAL VOLUME MODEL #	PRICE	ANALOG VOLUME MODEL #	PRICE
Gen4 DirectAccess	Nurse, TV, 0-9 Keypad	4C19J-0-DV	\$102.95	4C19J-0-AV	\$107.95
	Nurse, TV, 0-9 Keypad, 1 Light	4C19J-1-DV	\$104.95	4C19J-1-AV	\$109.95
	Nurse, TV, 0-9 Keypad, 2 Lights	4C19J-2-DV	\$106.95	4C19J-2-AV	\$111.95
Gen4 Digital	Nurse, TV	4D19J-0-DV	\$89.95	4D19J-0-AV	\$94.95
	Nurse, TV, 1 Light	4D19J-1-DV	\$91.95	4D19J-1-AV	\$96.95
	Nurse, TV, 2 Lights	4D19J-2-DV	\$93.95	4D19J-2-AV	\$98.95
Gen III Analog	Nurse, TV	-	-	34200-001	\$50.93

**NOTE:** CALL for complete Pillow Speaker part numbers.

Part numbers are based on standard wiring and 8 ft. cable length. Call for additional options including ear jack, alternate cable length, and auxiliaries.

**PILLOW SPEAKER REPAIR**

DESCRIPTION	PRICE
Repair of Gen4 DirectAccess, Gen4 Digital, Gen4 Interactive, or Gen III Analog	CALL

**PILLOW SPEAKER TESTER**

DESCRIPTION	MODEL #	PART #	PRICE
Tester with one module	CT-300	6333	\$395.95
Additional module for this nurse call system	CALL	CALL	\$75.95

**PILLOW SPEAKER REPLACEMENT CABLES**

DESCRIPTION	LENGTH	MODEL #	PART #	PRICE
Replacement Cable for Gen4 Pillow Speaker	8'	CAD-4200	CALL	\$28.16
Replacement Cable for Gen III Pillow Speaker	8'	CA3800J	CALL	\$32.95

**CALL CORDS** (1/4" accessories may require an adaptor)

DESCRIPTION	LENGTH	8-PIN DIN MODEL #	PART #	PRICE	1/4" PLUG MODEL #	PART #	PRICE
Gen4 Sealed Call Cord	8'	SCC-4201-101-U	13286	\$26.95	SCC-0101-080-U	13260	\$16.95
Gen4 Sealed Call Cord	12'	-	-	-	SCC-0101-120-U	13262	\$18.95
Classic Call Cord	8'	CC96-300	5851	\$24.95	CC96-010	5822	\$14.95
Classic Call Cord	12'	CC144-466	5755	\$28.95	CC144-010	5733	\$16.95
BreathCall	9'	GEB-155	7388	\$165.95	GEB-010	7380	\$136.95
E-Z Call	10'	-	-	-	GEE-010	7402	\$64.95
Mechanical Pad	10'	GEM-180	7423	\$47.95	GEM-0000-AGY	7407	\$43.95
PadCall	8'	GEA-135	7359	\$72.95	GEA-030	7351	\$50.95
PressCall	8'	GEP-265	7450	\$61.95	GEP-140	7441	\$39.95

**ADAPTORS** (see page 25 for descriptions of adaptor types)

TYPE	PLUG STYLE	RECEPTACLE 1	RECEPTACLE 2	RECEPTACLE 3	MODEL #	PART #	PRICE
Box	8-pin DIN	8-pin DIN	1/4" jack (nurse call)	-	ADP-4200-101	3387	\$84.95
Pinsaver Jumper	8-pin DIN	8-pin DIN	-	-	JUP-1008-010-002	8492	\$21.95

**DUMMY PLUGS**

DESCRIPTION	MODEL #	PART #	PRICE
8-Pin DIN, no cord	DP-062	6840	\$8.95
8-Pin DIN, 6" Poly Cord	DP-066	6842	\$10.95

**REPLACEMENT PILLOW SPEAKERS AND ACCESSORIES FOR:**

**Jeron® Provider 790**



**PILLOW SPEAKERS**

TYPE	FEATURES	DIGITAL VOLUME MODEL #	PRICE	ANALOG VOLUME MODEL #	PRICE
Gen4 DirectAccess	Nurse, TV, 0-9 Keypad	4C420-0-DV	\$136.95	4C420-0-AV	\$141.95
	Nurse, TV, 0-9 Keypad, 1 Light	4C420-1-DV	\$138.95	4C420-1-AV	\$143.95
	Nurse, TV, 0-9 Keypad, 2 Lights	4C420-2-DV	\$140.95	4C420-2-AV	\$145.95

**NOTE:** CALL for complete Pillow Speaker part numbers.

Part numbers are based on standard wiring and 8 ft. cable length. Call for additional options including ear jack, alternate cable length, and auxiliaries.

**PILLOW SPEAKER REPAIR**

DESCRIPTION	PRICE
Repair of Gen4 DirectAccess, or Gen4 Interactive	CALL

**PILLOW SPEAKER TESTER** (May not test all functions of every model — call for details)

DESCRIPTION	MODEL #	PART #	PRICE
Tester with one module	CT-300	6333	\$395.95
Additional module for this nurse call system	CALL	CALL	\$75.95

**PILLOW SPEAKER REPLACEMENT CABLES**

DESCRIPTION	LENGTH	MODEL #	PART #	PRICE
Replacement Cable for Gen4 Pillow Speaker	8'	CAD-4200	CALL	\$28.16

**CALL CORDS** (1/4" accessories may require an adaptor)

DESCRIPTION	LENGTH	1/4" PLUG MODEL #	PART #	PRICE
Gen4 Sealed Call Cord	8'	SCC-0101-080-U	13260	\$16.95
Gen4 Sealed Call Cord	12'	SCC-0101-120-U	13262	\$18.95
Classic Call Cord	8'	CC96-010	5822	\$14.95
Classic Call Cord	12'	CC144-010	5733	\$16.95
BreathCall	9'	GEB-010	7380	\$136.95
E-Z Call	10'	GEE-010	7402	\$64.95
Mechanical Pad	10'	GEM-0000-AGY	7407	\$43.95
PadCall	8'	GEA-030	7351	\$50.95
PressCall	8'	GEP-140	7441	\$39.95

**ADAPTORS** (see page 25 for descriptions of adaptor types)

TYPE	PLUG STYLE	RECEPTACLE 1	RECEPTACLE 2	RECEPTACLE 3	MODEL #	PART #	PRICE
Box	8-pin DIN	8-pin DIN	1/4" jack (nurse call)	-	ADP-4200-101	3387	\$84.95

**DUMMY PLUGS**

DESCRIPTION	MODEL #	PART #	PRICE
8-Pin DIN, no cord	DP-062	6840	\$8.95
8-Pin DIN, 6" Poly Cord	DP-066	6842	\$10.95

**REPLACEMENT PILLOW SPEAKERS AND ACCESSORIES FOR:**

**Rauland® Responder® III, 3000**

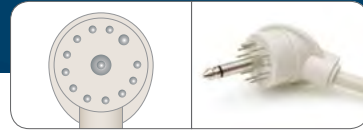

**PILLOW SPEAKERS**

TYPE	FEATURES	DIGITAL VOLUME MODEL #	PRICE	ANALOG VOLUME MODEL #	PRICE
Gen4 DirectAccess	Nurse, TV, 0-9 Keypad	4C100-0-DV	\$94.95	4C100-0-AV	\$99.95
	Nurse, TV, 0-9 Keypad, 1 Light	4C100-1-DV	\$96.95	4C100-1-AV	\$101.95
	Nurse, TV, 0-9 Keypad, 2 Lights	4C100-2-DV	\$98.95	4C100-2-AV	\$103.95
Gen4 Digital	Nurse, TV	4D100-0-DV	\$85.95	4D100-0-AV	\$90.95
	Nurse, TV, 1 Light	4D100-1-DV	\$87.95	4D100-1-AV	\$92.95
	Nurse, TV, 2 Lights	4D100-2-DV	\$89.95	4D100-2-AV	\$94.95
Gen III Analog	Nurse, TV	-	-	3412-001	\$75.25
	Nurse, TV, 1 Light (Pins 6 and 8)*	-	-	3412-006	\$77.35
	Nurse, TV, 1 Light (Pins 9 and 11)	-	-	3412-016	\$77.35
	Nurse, TV, 2 Lights	-	-	3412-002	\$79.45

**NOTE:** CALL for complete Pillow Speaker part numbers.

Part numbers are based on standard wiring and 8 ft. cable length. Call for additional options including ear jack, alternate cable length, and auxiliaries.

**PILLOW SPEAKER REPAIR**

DESCRIPTION	PRICE
Repair of Gen4 DirectAccess, Gen4 Digital, Gen4 Interactive, or Gen III Analog	CALL

**PILLOW SPEAKER TESTER**

DESCRIPTION	MODEL #	PART #	PRICE
Tester with one module	CT-300	6333	\$395.95
Additional module for this nurse call system	CALL	CALL	\$84.95

**PILLOW SPEAKER REPLACEMENT CABLES**

DESCRIPTION	LENGTH	MODEL #	PART #	PRICE
Replacement Cable for Gen4 Pillow Speaker	8'	CAD-1000	CALL	\$32.16
Replacement Cable for Gen III Pillow Speaker	8'	CA3412	CALL	\$35.95

**CALL CORDS** (1/4" accessories may require an adaptor)

DESCRIPTION	LENGTH	1/4" PLUG MODEL #	PART #	PRICE
Gen4 Sealed Call Cord	8'	SCC-0101-080-U	13260	\$16.95
Gen4 Sealed Call Cord	12'	SCC-0101-120-U	13262	\$18.95
Classic Call Cord	8'	CC96-010	5822	\$14.95
Classic Call Cord	12'	CC144-010	5733	\$16.95
BreathCall	9'	GEB-010	7380	\$136.95
E-Z Call	10'	GEE-010	7402	\$64.95
Mechanical Pad	10'	GEM-0000-AGY	7407	\$43.95
PadCall	8'	GEA-030	7351	\$50.95
PressCall	8'	GEP-140	7441	\$39.95

**ADAPTORS** (see page 25 for descriptions of adaptor types)

TYPE	PLUG STYLE	RECEPTACLE 1	RECEPTACLE 2	RECEPTACLE 3	MODEL #	PART #	PRICE
Box	12-pin	12-pin	1/4" jack (nurse call)	-	ADP-0412-101	3266	\$79.95
Box	12-pin	12-pin	1/4" jack (nurse call)	1/4" jack (TV)	ADP-0412-102	3267	\$89.95
Box	12-pin	12-pin	12-pin	-	ADP-0412-103	3268	\$97.95

**DUMMY PLUGS**

DESCRIPTION	MODEL #	PART #	PRICE
1/4" plug, Metal Plug, Overmolded, 6" Poly Cord	DP-020	6834	\$5.25
12-Pin, Jump 7 and 10	DP-200	6856	\$11.95

**REPLACEMENT PILLOW SPEAKERS AND ACCESSORIES FOR:**

**Rauland® Responder® III+, IV, and 4000 systems**



**PILLOW SPEAKERS**

TYPE	FEATURES	DIGITAL VOLUME MODEL #	PRICE	ANALOG VOLUME MODEL #	PRICE
Gen4 DirectAccess	Nurse, TV, 0-9 Keypad	4C190-0-DV	\$97.95	4C190-0-AV	\$102.95
	Nurse, TV, 0-9 Keypad, 1 Light	4C190-1-DV	\$99.95	4C190-1-AV	\$104.95
	Nurse, TV, 0-9 Keypad, 2 Lights	4C190-2-DV	\$101.95	4C190-2-AV	\$106.95
Gen4 Digital	Nurse, TV	4D190-0-DV	\$84.95	4D190-0-AV	\$89.95
	Nurse, TV, 1 Light	4D190-1-DV	\$86.95	4D190-1-AV	\$91.95
	Nurse, TV, 2 Lights	4D190-2-DV	\$88.95	4D190-2-AV	\$93.95
Gen III Analog	Nurse, TV	-	-	3800-001	\$75.25
	Nurse, TV, 1 Light	-	-	3800-002	\$77.35
	Nurse, TV, 2 Lights	-	-	3800-003	\$79.45

**NOTE:** CALL for complete Pillow Speaker part numbers.

Part numbers are based on standard wiring and 8 ft. cable length. Call for additional options including ear jack, alternate cable length, and auxiliaries.

**PILLOW SPEAKER REPAIR**

DESCRIPTION	PRICE
Repair of Gen4 DirectAccess, Gen4 Digital, Gen4 Interactive, or Gen III Analog	CALL

**PILLOW SPEAKER TESTER**

DESCRIPTION	MODEL #	PART #	PRICE
Tester with one module	CT-300	6333	\$395.95
Additional module for this nurse call system	CALL	CALL	\$75.95

**PILLOW SPEAKER REPLACEMENT CABLES**

DESCRIPTION	LENGTH	MODEL #	PART #	PRICE
Replacement Cable for Gen4 Pillow Speaker	8'	CAD-1900R	CALL	\$28.16
Replacement Cable for Gen III Pillow Speaker	8'	CA3800R	CALL	\$32.95

**CALL CORDS** (1/4" accessories may require an adaptor)

DESCRIPTION	LENGTH	8-PIN DIN MODEL #	PART #	PRICE	1/4" PLUG MODEL #	PART #	PRICE
Gen4 Sealed Call Cord	8'	SCC-1901-080-U	13266	\$26.95	SCC-0101-080-U	13260	\$16.95
Gen4 Sealed Call Cord	12'	-	-	-	SCC-0101-120-U	13262	\$18.95
Classic Call Cord	8'	CC96-750	5860	\$24.95	CC96-010	5822	\$14.95
Classic Call Cord	12'	CC144-462	5754	\$27.95	CC144-010	5733	\$16.95
BreathCall	9'	GEB-150	7387	\$165.95	GEB-010	7380	\$136.95
E-Z Call	10'	-	-	-	GEE-010	7402	\$64.95
Mechanical Pad	10'	GEM-18	7422	\$47.95	GEM-0000-AGY	7407	\$43.95
PadCall	8'	GEA-130	7357	\$72.95	GEA-030	7351	\$50.95
PressCall	8'	GEP-260	7447	\$61.95	GEP-140	7441	\$39.95

**ADAPTORS** (see page 25 for descriptions of adaptor types)

SYSTEM	TYPE	PLUG STYLE	RECEPTACLE 1	RECEPTACLE 2	RECEPTACLE 3	MODEL #	PART #	PRICE
Responder III+, IV	Box	8-pin DIN	8-pin DIN	1/4" jack	NA	ADP-0800-113	3294	\$79.95
Responder III+, IV	Box	8-pin DIN	8-pin DIN	1/4" jack	1/4" (TV)	ADP-0800-117	3297	\$89.95
Responder III+, IV	Box	8-pin DIN	8-pin DIN	8-pin DIN	NA	ADP-0800-118	3298	\$83.95
Responder III+, IV	Conversion	8-pin DIN	1/4" jack	NA	NA	AD-120	3235	\$29.95
Responder III+, IV	Cordsaver	8-pin DIN	8-pin DIN	NA	NA	JUP-1000-010-002	8482	\$18.95
Responder III+, IV	Jumper	8-pin DIN	8-pin DIN	8-pin DIN	NA	JUP-1100-001	18153	\$48.95
Responder III+, IV	Jumper	8-pin DIN	8-pin DIN	1/4" jack (nurse)	NA	JUP-1101-001	18193	\$52.95
Responder 4000	Box	8-pin DIN	8-pin DIN	8-pin DIN	NA	ADP-0800-110	3291	\$83.95
Responder 4000	Box	8-pin DIN	8-pin DIN	8-pin DIN	1/4" jack	ADP-0800-115	3296	\$93.95
Responder 4000	Jumper	8-pin DIN	8-pin DIN	8-pin DIN	NA	JUP-1100-002	18154	\$48.95

**DUMMY PLUGS**

DESCRIPTION	MODEL #	PART #	PRICE
8-Pin DIN, 6" cord	DP-140	6852	\$9.95
1/4" plug, Metal Plug, Overmolded, 6" Poly Cord	DP-020	6834	\$5.25

## REPLACEMENT PILLOW SPEAKERS AND ACCESSORIES FOR:

### Rauland® Responder® 5 systems



#### PILLOW SPEAKERS

TYPE	FEATURES	DIGITAL VOLUME MODEL #	PRICE	ANALOG VOLUME MODEL #	PART #	PRICE
Gen4 DirectAccess	Nurse, TV, 0-9 Keypad	4C410-0-DV	\$136.95	4C410-0-AV	Call	\$141.95
	Nurse, TV, 0-9 Keypad, 1 Light	4C410-1-DV	\$138.95	4C410-1-AV	Call	\$143.95
	Nurse, TV, 0-9 Keypad, 2 Lights	4C410-2-DV	\$140.95	4C410-2-AV	Call	\$145.95
Gen4 Digital	Nurse, TV	4D410-0-DV	\$131.95	4D410-0-AV	Call	\$136.95
	Nurse, TV, 1 Light	4D410-1-DV	\$133.95	4D410-1-AV	Call	\$138.95
	Nurse, TV, 2 Lights	4D410-2-DV	\$135.95	4D410-2-AV	Call	\$140.95

**NOTE:** Call for complete Pillow Speaker part numbers. Part numbers are based on standard wiring and 10 ft. cable length. Call for additional options including ear jack, alternate cable length, and auxiliaries. All Units ship standard with Water, Pain, and Toilet Nurse Call auxiliaries.

#### PILLOW SPEAKER REPAIR

DESCRIPTION	PRICE
Repair of Gen4 DirectAccess, Gen4 Digital, or Gen4 Interactive	CALL

#### PILLOW SPEAKER TESTER

DESCRIPTION	MODEL #	PART #	PRICE
Responder 5 <b>PILLOW SPEAKER TESTER</b>	CT-5	14976	\$395.95

#### PILLOW SPEAKER REPLACEMENT CABLES

DESCRIPTION	LENGTH	MODEL #	PART #	PRICE
Replacement Cable for Gen4 Pillow Speaker	10'	CAD-9000	Call	\$34.16

#### CALL CORDS (1/4" accessories may require an adaptor)

DESCRIPTION	LENGTH	DIN MODEL #	PART #	PRICE	1/4" PLUG MODEL #	PART #	PRICE
Gen4 Sealed Call Cord	10'	SCC-4101-100-U	13285	\$33.95	SCC-0101-080-U	13260	\$16.95
Gen4 Sealed Call Cord	12'	-	-	-	SCC-0101-120-U	13262	\$18.95
BreathCall	9'	GEB-150	7387	\$165.95	GEB-010	7380	\$136.95
E-Z Call	10'	-	-	-	GEE-010	7402	\$64.95
Mechanical Pad	10'	GEM-18	7422	\$47.95	GEM-0000-AGY	7407	\$43.95
PadCall	8'	GEA-130	7357	\$72.95	GEA-030	7351	\$50.95
PressCall	8'	GEP-260	7447	\$61.95	GEP-140	7441	\$39.95

#### CORD SAVER

DESCRIPTION	LENGTH	MODEL #	PART #	PRICE
9-pin DINcord saver with clamp	2'	JUP-9000-2	8518	\$35.95

## THE CORD SAVER

When a pillow speaker cable gets pulled from the patient station, there's potential for damage, which can cause intermittent nurse call functionality, false alarms, and patient station repair costs.

Our cord saver breakaway cable secures to the wall and safely breaks apart at a point away from the patient station, reducing cable replacement and patient station repairs.

- 9-Pin DIN Male to 9-Pin DIN Female
- Authorized by Rauland for their Responder 5 system
- Guide markings to match system and pillow speaker cable



## REPLACEMENT PILLOW SPEAKERS AND ACCESSORIES FOR:

### SimplexGrinnell® EZCare™



#### PILLOW SPEAKERS

TYPE	FEATURES	DIGITAL VOLUME MODEL #	PRICE	ANALOG VOLUME MODEL #	PRICE
Gen4 DirectAccess	Nurse, TV, 0-9 Keypad	4C290-0-DV	\$121.95	4C290-0-AV	\$126.95
	Nurse, TV, 0-9 Keypad, 1 Light	4C290-1-DV	\$123.95	4C290-1-AV	\$128.95
	Nurse, TV, 0-9 Keypad, 2 Lights	4C290-2-DV	\$125.95	4C290-2-AV	\$130.95
	Nurse, TV, 0-9 Keypad	4C290-2-DVPSS-0	\$136.95	4C290-2-AVPSS-0	\$141.95
	Nurse, TV, 0-9 Keypad, 2 Lights	4C290-2-DVPSS-2	\$140.95	4C290-2-AVPSS-2	\$145.95
Gen4 Digital	Nurse, TV	4D290-0-DV	\$107.95	4D290-0-AV	\$112.95
	Nurse, TV, 1 Light	4D290-1-DV	\$109.95	4D290-1-AV	\$114.95
	Nurse, TV, 2 Lights	4D290-2-DV	\$111.95	4D290-2-AV	\$116.95
	Nurse, TV	4D290-2-DVPSS-0	\$131.95	4C290-2-AVPSS-0	\$136.95
	Nurse, TV, 2 Lights	4D290-2-DVPSS-2	\$135.95	4C290-2-AVPSS-2	\$140.95
Gen III Analog	Nurse, TV	-	-	31500-001	\$91.00
	Nurse, TV, 1 Light	-	-	31500-105	\$93.10
	Nurse, TV, 2 Lights	-	-	31500-303	\$95.20

**NOTE:** CALL for complete Pillow Speaker part numbers. Part numbers are based on standard wiring and 8 ft. cable length. Call for additional options including ear jack, alternate cable length, and auxiliaries.

#### PILLOW SPEAKER REPAIR

DESCRIPTION	PRICE
Repair of Gen4 DirectAccess, Gen4 Digital, Gen4 Interactive, or Gen III Analog	CALL

#### PILLOW SPEAKER TESTER (May not test all functions of every model — call for details)

DESCRIPTION	MODEL #	PART #	PRICE
Tester with one module	CT-300	6333	\$395.95
Additional module for this nurse call system	CALL	CALL	\$86.95

#### PILLOW SPEAKER REPLACEMENT CABLES

DESCRIPTION	LENGTH	MODEL #	PART #	PRICE
Replacement Cable for Gen4 Pillow Speaker	8'	CAD-2900	CALL	\$48.16
Replacement Cable for Gen III Pillow Speaker	8'	CA31500	CALL	\$47.95

#### CALL CORDS (1/4" accessories may require an adaptor)

DESCRIPTION	LENGTH	15-PIN MODEL #	PART #	PRICE	1/4" PLUG MODEL #	PART #	PRICE
Gen4 Sealed Call Cord	8'	SCC-2908	13277	\$46.95	SCC-0101-080-N	13259	\$16.95
Gen4 Sealed Call Cord	12'	-	-	-	SCC-0101-120-N	13261	\$18.95
Classic Call Cord	8'	CC96-983	5874	\$46.95	CC96-010	5822	\$14.95
Classic Call Cord	12'	-	-	-	CC144-010	5733	\$16.95
BreathCall	9'	GEB-375	7400	\$179.95	GEB-010	7380	\$136.95
E-Z Call	10'	-	-	-	GEE-010	7402	\$64.95
Mechanical Pad	10'	GEM-478	7434	\$52.95	GEM-0000-AGY	7407	\$43.95
PadCall	8'	GEA-360	7379	\$144.95	GEA-030	7351	\$50.95
PressCall	8'	GEP-670	7472	\$136.95	GEP-140	7441	\$39.95

#### ADAPTORS (see page 25 for descriptions of adaptor types)

TYPE	PLUG STYLE	RECEPTACLE 1	RECEPTACLE 2	RECEPTACLE 3	MODEL #	PART #	PRICE
Box	15-pin	15-pin	1/4" jack (nurse call)	1/4" jack (TV)	ADP-1500F-102	3350	\$170.95
Jumper	15-pin	1/4" jack	-	-	JUP-1056-001-001	8515	\$39.95

#### DUMMY PLUGS

DESCRIPTION	MODEL #	PART #	PRICE
15-Pin, 6" Poly Cord	DP-095	6845	\$32.95

**REPLACEMENT PILLOW SPEAKERS AND ACCESSORIES FOR:**

**TekTone® Tek-CARE® NC300 II, Tek-CARE 400**



**PILLOW SPEAKERS**

TYPE	FEATURES	DIGITAL VOLUME MODEL #	PRICE	ANALOG VOLUME MODEL #	PRICE
Gen4 DirectAccess	Nurse, TV, 0-9 Keypad	4C19E-0-DV	\$101.95	4C19E-0-AV	\$106.95
	Nurse, TV, 0-9 Keypad, 1 Light	4C19E-1-DV	\$103.95	4C19E-1-AV	\$108.95
	Nurse, TV, 0-9 Keypad, 2 Lights	4C19E-2-DV	\$105.95	4C19E-2-AV	\$110.95
Gen4 Digital	Nurse, TV	4D19E-0-DV	\$88.95	4D19E-0-AV	\$93.95
	Nurse, TV, 1 Light	4D19E-1-DV	\$90.95	4D19E-1-AV	\$95.95
	Nurse, TV, 2 Lights	4D19E-2-DV	\$92.95	4D19E-2-AV	\$97.95
Gen III Analog	Nurse, TV	-	-	3800-501	\$75.25

**NOTE:** CALL for complete Pillow Speaker part numbers.

Part numbers are based on standard wiring and 8 ft. cable length. Call for additional options including ear jack, alternate cable length, and auxiliaries.

**PILLOW SPEAKER REPAIR**

DESCRIPTION	PRICE
Repair of Gen4 DirectAccess, Gen4 Digital, Gen4 Interactive, or Gen III Analog	CALL

**PILLOW SPEAKER TESTER**

DESCRIPTION	MODEL #	PART #	PRICE
Tester with one module	CT-300	6333	\$395.95
Additional module for this nurse call system	CALL	CALL	\$75.95

**PILLOW SPEAKER REPLACEMENT CABLES**

DESCRIPTION	LENGTH	MODEL #	PART #	PRICE
Replacement Cable for Gen4 Pillow Speaker	8'	CAD-1900T	CALL	\$28.16
Replacement Cable for Gen III Pillow Speaker	8'	CA3800T	CALL	\$31.95

**CALL CORDS** (1/4" accessories may require an adaptor)

DESCRIPTION	LENGTH	8-PIN DIN MODEL #	PART #	PRICE	1/4" PLUG MODEL #	PART #	PRICE
Gen4 Sealed Call Cord	8'	SCC-1901-082-U	13269	\$26.95	SCC-0101-080-U	13260	\$16.95
Gen4 Sealed Call Cord	12'	-	-	-	SCC-0101-120-U	13262	\$18.95
Classic Call Cord	8'	CC96-970	5871	\$24.95	CC96-010	5822	\$14.95
Classic Call Cord	12'	-	-	-	CC144-010	5733	\$16.95
BreathCall	9'	-	-	-	GEB-010	7380	\$136.95
E-Z Call	10'	-	-	-	GEE-010	7402	\$64.95
Mechanical Pad	10'	GEM-476	7432	\$47.95	GEM-0000-AGY	7407	\$43.95
PadCall	8'	GEA-139	7362	\$72.95	GEA-030	7351	\$50.95
PressCall	8'	GEP-660	7471	\$61.95	GEP-140	7441	\$39.95

**ADAPTORS** (see page 25 for descriptions of adaptor types)

TYPE	PLUG STYLE	RECEPTACLE 1	RECEPTACLE 2	RECEPTACLE 3	MODEL #	PART #	PRICE
Box	8-pin DIN	8-pin DIN	1/4" jack (nurse call)	-	ADP-0800-109	3290	\$79.95
Box	8-pin DIN	8-pin DIN	1/4" jack (nurse call)	1/4" jack (TV)	ADP-0800-121	3300	\$89.95
Box	8-pin DIN	8-pin DIN	8-pin DIN	1/4" jack (nurse call)	ADP-0800-108	3289	\$93.95

**DUMMY PLUGS**

DESCRIPTION	MODEL #	PART #	PRICE
8-Pin DIN, 6" cord	DP-141	6853	\$9.95

**REPLACEMENT PILLOW SPEAKERS AND ACCESSORIES FOR:**

**TekTone® Tek-CARE® NC3000 II**



**PILLOW SPEAKERS**

TYPE	FEATURES	DIGITAL VOLUME MODEL #	PRICE	ANALOG VOLUME MODEL #	PRICE
Gen4 DirectAccess	Nurse, TV, 0-9 Keypad	4C210-0-DV	\$89.95	4C210-0-AV	\$94.95
	Nurse, TV, 0-9 Keypad, 1 Light	4C210-1-DV	\$91.95	4C210-1-AV	\$96.95
	Nurse, TV, 0-9 Keypad, 2 Lights	4C210-2-DV	\$93.95	4C210-2-AV	\$98.95
Gen4 Digital	Nurse, TV	4D210-0-DV	\$84.95	4D210-0-AV	\$89.95
	Nurse, TV, 1 Light	4D210-1-DV	\$86.95	4D210-1-AV	\$91.95
	Nurse, TV, 2 Lights	4D210-2-DV	\$88.95	4D210-2-AV	\$93.95
Gen III Analog	Nurse, TV	-	-	3808-011	\$74.20
	Nurse, TV, Radio	-	-	3808-328	\$76.30

**NOTE:** CALL for complete Pillow Speaker part numbers.

Part numbers are based on standard wiring and 8 ft. cable length. Call for additional options including ear jack, alternate cable length, and auxiliaries.

**PILLOW SPEAKER REPAIR**

DESCRIPTION	PRICE
Repair of Gen4 DirectAccess, Gen4 Digital, Gen4 Interactive, or Gen III Analog	CALL

**PILLOW SPEAKER TESTER**

DESCRIPTION	MODEL #	PART #	PRICE
Tester with one module	CT-300	6333	\$395.95
Additional module for this nurse call system	CALL	CALL	\$85.95

**PILLOW SPEAKER REPLACEMENT CABLES**

DESCRIPTION	LENGTH	MODEL #	PART #	PRICE
Replacement Cable for Gen4 Pillow Speaker	8'	CAD-2100T	CALL	\$26.16
Replacement Cable for Gen III Pillow Speaker	8'	CA3808T	CALL	\$29.95

**CALL CORDS** (1/4" accessories may require an adaptor)

DESCRIPTION	LENGTH	8-PIN MODULAR MODEL #	PART #	PRICE	1/4" PLUG MODEL #	PART #	PRICE
Gen4 Sealed Call Cord	8'	SCC-2101-080-N	13273	\$21.95	SCC-0101-080-U	13260	\$16.95
Gen4 Sealed Call Cord	12'	-	-	-	SCC-0101-120-U	13262	\$18.95
Classic Call Cord	8'	CC96-080	5835	\$19.95	CC96-010	5822	\$14.95
Classic Call Cord	12'	-	-	-	CC144-010	5733	\$16.95
BreathCall	9'	GEB-170	7391	\$165.95	GEB-010	7380	\$136.95
E-Z Call	10'	-	-	-	GEE-010	7402	\$64.95
Mechanical Pad	10'	GEM-471	7430	\$47.95	GEM-0000-AGY	7407	\$43.95
PadCall	8'	GEA-145	7364	\$72.95	GEA-030	7351	\$50.95
PressCall	8'	GEP-310	7453	\$61.95	GEP-140	7441	\$39.95

**ADAPTORS**(see page 25 for descriptions of adaptor types)

TYPE	PLUG STYLE	RECEPTACLE 1	RECEPTACLE 2	RECEPTACLE 3	MODEL #	PART #	PRICE
Box	8-Pin Modular	1/4" jack (nurse call)	-	-	ADP-0808-101	3322	\$77.95
Box	8-Pin Modular	1/4" jack (nurse call)	1/4" jack (TV)	-	ADP-0808-102	3323	\$87.95
Box	8-Pin Modular	8-Pin Modular	8-Pin Modular	-	ADP-0808-103	3324	\$91.95
Conversion	8-Pin Modular	1/4" jack (nurse call)	-	-	AD-030	3212	\$30.95

**DUMMY PLUGS**

DESCRIPTION	MODEL #	PART #	PRICE
8-Pin Modular, 6" Poly Cord	DP-082	6844	\$8.95

**REPLACEMENT PILLOW SPEAKERS AND ACCESSORIES FOR:**

**West-Com West-Call® 1000, 8000, Endeavor, Marc II**

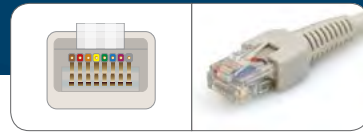

**PILLOW SPEAKERS**

TYPE	FEATURES	DIGITAL VOLUME MODEL #	PRICE	ANALOG VOLUME MODEL #	PRICE
Gen4 DirectAccess	Nurse, TV, 0-9 Keypad	4C215-0-DV	\$87.95	4C215-0-AV	\$92.95
	Nurse, TV, 0-9 Keypad, 1 Light	4C215-1-DV	\$89.95	4C215-1-AV	\$94.95
	Nurse, TV, 0-9 Keypad, 2 Lights	4C215-2-DV	\$91.95	4C215-2-AV	\$96.95
Gen4 Digital	Nurse, TV	4D215-0-DV	\$81.95	4D215-0-AV	\$86.95
	Nurse, TV, 1 Light	4D215-1-DV	\$83.95	4D215-1-AV	\$88.95
	Nurse, TV, 2 Lights	4D215-2-DV	\$85.95	4D215-2-AV	\$90.95
Gen III Analog	Nurse, TV	-	-	3808-002	\$70.00
	Nurse, TV, 1 Light	-	-	3808-021	\$72.10
	Nurse, TV, 2 Lights	-	-	3808-010	\$74.20

**NOTE:** CALL for complete Pillow Speaker part numbers.

Part numbers are based on standard wiring and 8 ft. cable length. Call for additional options including ear jack, alternate cable length, and auxiliaries.

**PILLOW SPEAKER REPAIR**

DESCRIPTION	PRICE
Repair of Gen4 DirectAccess, Gen4 Digital, Gen4 Interactive, or Gen III Analog	CALL

**PILLOW SPEAKER TESTER**

DESCRIPTION	MODEL #	PART #	PRICE
Tester with one module	CT-300	6333	\$395.95
Additional module for this nurse call system	CALL	CALL	\$85.95

**PILLOW SPEAKER REPLACEMENT CABLES**

DESCRIPTION	LENGTH	MODEL #	PART #	PRICE
Replacement Cable for Gen4 Pillow Speaker	8'	CAD-2100WC	CALL	\$26.16
Replacement Cable for Gen III Pillow Speaker	8'	CA3808	CALL	\$29.95

**CALL CORDS** (1/4" accessories may require an adaptor)

DESCRIPTION	LENGTH	8-PIN MODULAR MODEL #	PART #	PRICE	1/4" PLUG MODEL #	PART #	PRICE
Gen4 Sealed Call Cord	8'	SCC-2101-080-N	13272	\$21.95	SCC-0101-080-N	13259	\$16.95
Gen4 Sealed Call Cord	12'	-	-	-	SCC-0101-120-N	13261	\$18.95
Classic Call Cord	8'	CC96-080	5835	\$19.95	CC96-010	5822	\$14.95
Classic Call Cord	12'	-	-	-	CC144-010	5733	\$16.95
BreathCall	9'	GEB-170	7391	\$165.95	GEB-010	7380	\$136.95
E-Z Call	10'	-	-	-	GEE-010	7402	\$64.95
Mechanical Pad	10'	GEM-471	7430	\$47.95	GEM-0000-AGY	7407	\$43.95
PadCall	8'	GEA-145	7364	\$72.95	GEA-030	7351	\$50.95
PressCall	8'	GEP-310	7453	\$61.95	GEP-140	7441	\$39.95

**ADAPTORS** (see page 25 for descriptions of adaptor types)

TYPE	PLUG STYLE	RECEPTACLE 1	RECEPTACLE 2	RECEPTACLE 3	MODEL #	PART #	PRICE
Box	8-pin Modular	8-pin Modular	1/4" jack (nurse call)	-	ADP-0808-101	3322	\$77.95
Box	8-pin Modular	8-pin Modular	1/4" jack (nurse call)	1/4" jack (TV)	ADP-0808-102	3323	\$87.95
Box	8-pin Modular	8-pin Modular	8-pin Modular	-	ADP-0808-103	3324	\$91.95
Conversion	8-pin Modular	1/4" jack (nurse call)	-	-	AD-030	3212	\$30.95

**DUMMY PLUGS**

DESCRIPTION	MODEL #	PART #	PRICE
1/4" plug, Metal Plug, Overmolded, 6" Poly Cord	DP-020	6834	\$5.25
8-Pin Modular, 6" Poly Cord	DP-082	6844	\$8.95

**REPLACEMENT PILLOW SPEAKERS AND ACCESSORIES FOR:**

**West-Com Odyssey, Odyssey Plus, Novus®**



**PILLOW SPEAKERS**

TYPE	FEATURES	DIGITAL VOLUME MODEL #	PRICE	ANALOG VOLUME MODEL #	PRICE
Gen4 DirectAccess	Nurse, TV, 0-9 Keypad	4C240-0-DV	\$94.95	4C240-0-AV	\$99.95
	Nurse, TV, 0-9 Keypad, Light	4C240-1-DV	\$96.95	4C240-1-AV	\$101.95
	Nurse, TV, 0-9 Keypad, 2 Lights	4C240-2-DV	\$98.95	4C240-2-AV	\$103.95
	Nurse, TV, 0-9 Keypad, 2 Lights, Pain, Bed Pan	4C240-4-DV	\$102.95	4C240-4-AV	\$107.95
Gen4 Digital	Nurse, TV	4D240-0-DV	\$84.95	4D240-0-AV	\$89.95
	Nurse, TV, Light	4D240-1-DV	\$86.95	4D240-1-AV	\$91.95
	Nurse, TV, 2 Lights	4D240-2-DV	\$88.95	4D240-2-AV	\$93.95
Gen III Analog	Nurse, TV, 2 Lights, Pain Med, Bed Pan	4D240-4-DV	\$92.95	4D240-4-AV	\$97.95
	Nurse, TV	-	-	31010-004	\$76.30
	Nurse, TV, Pain Med, Bed Pan	-	-	31010-002	\$80.50
	Nurse, TV, 2 Lights	-	-	31010-003	\$80.50
	Nurse, TV, 2 Lights, Pain Med, Bed Pan	-	-	31010-001	\$84.70

**NOTE:** CALL for complete Pillow Speaker part numbers.

Part numbers are based on standard wiring and 8 ft. cable length. Call for additional options including ear jack, alternate cable length, and auxiliaries.

**PILLOW SPEAKER REPAIR**

DESCRIPTION	PRICE
Repair of Gen4 DirectAccess, Gen4 Digital, Gen4 Interactive, or Gen III Analog	CALL

**PILLOW SPEAKER TESTER**

DESCRIPTION	MODEL #	PART #	PRICE
Tester with one module	CT-300	6333	\$395.95
Additional module for this nurse call system	CALL	CALL	\$87.95

**PILLOW SPEAKER REPLACEMENT CABLES**

DESCRIPTION	LENGTH	MODEL #	PART #	PRICE
Replacement Cable for Gen4 Pillow Speaker	8'	CAD-2400	CALL	\$28.16
Replacement Cable for Gen III Pillow Speaker	8'	CA31010	CALL	\$31.16

**CALL CORDS** (1/4" accessories may require an adaptor)

DESCRIPTION	LENGTH	10-PIN MODULAR MODEL #	PART #	PRICE	1/4" PLUG MODEL #	PART #	PRICE
Gen4 Sealed Call Cord	8'	SCC-2402-080-U	13276	\$24.95	SCC-0101-080-U	13260	\$16.95
Gen4 Sealed Call Cord	12'	-	-	-	SCC-0101-120-U	13262	\$18.95
Classic Call Cord	8'	CC96-661	5857	\$22.95	CC96-010	5822	\$14.95
Classic Call Cord	12'	-	-	-	CC144-010	5733	\$16.95
BreathCall	9'	GEB-175	7392	\$175.95	GEB-010	7380	\$136.95
E-Z Call	10'	-	-	-	GEE-010	7402	\$64.95
Mechanical Pad	10'	GEM-480	15014	\$47.95	GEM-0000-AGY	7407	\$43.95
PadCall	8'	GEA-146	7365	\$83.95	GEA-030	7351	\$50.95
PressCall	8'	GEP-610	7468	\$63.95	GEP-140	7441	\$39.95

**ADAPTORS** (see page 25 for descriptions of adaptor types)

TYPE	PLUG STYLE	RECEPTACLE 1	RECEPTACLE 2	RECEPTACLE 3	MODEL #	PART #	PRICE
Box	10-pin Modular	10-pin Modular	1/4" jack (nurse call)	-	ADP-1010-102	3341	\$82.95
Box	10-pin Modular	10-pin Modular	1/4" jack (nurse call)	1/4" jack (TV)	ADP-1010-103	3342	\$92.95
Box	10-pin Modular	10-pin Modular	8-pin Modular	-	ADP-1010-104	3343	\$96.95
Jumper	10-pin Modular	10-pin Modular	-	-	JU06-311	8124	\$18.95

**DUMMY PLUGS**

DESCRIPTION	MODEL #	PART #	PRICE
1/4" plug, Metal Plug, Overmolded, 6" Poly Cord	DP-020	6834	\$5.25
10-Pin Modular, 6" Poly Cord	DP-255	6862	\$8.95

**REPLACEMENT PILLOW SPEAKERS AND ACCESSORIES FOR:**

**West-Com Odyssey, Odyssey Plus, Novus®**



**PILLOW SPEAKERS**

TYPE	FEATURES	DIGITAL VOLUME MODEL #	PRICE	ANALOG VOLUME MODEL #	PRICE
Gen4 DirectAccess	Nurse, TV, 0-9 Keypad	4C380-0-DV	\$116.95	4C380-0-AV	\$121.95
	Nurse, TV, 0-9 Keypad, 1 Light	4C380-1-DV	\$118.95	4C380-1-A	\$123.95
	Nurse, TV, 0-9 Keypad, 2 Lights	4C380-2-DV	\$120.95	4C380-2-AV	\$125.95
	Nurse, TV, 0-9 Keypad, 2 Lights, Pain, Bed Pan	4C380-4-DV	\$124.95	4C380-4-AV	\$129.95
Gen4 Digital	Nurse, TV	4D380-0-DV	\$102.95	4D380-0-AV	\$107.95
	Nurse, TV, 1 Light	4D380-1-DV	\$104.95	4D380-1-AV	\$109.95
	Nurse, TV, 2 Lights	4D380-2-DV	\$106.95	4D380-2-AV	\$111.95
	Nurse, TV, 2 Lights, Pain Med, Bed Pan	4D380-4-DV	\$110.95	4D380-4-AV	\$115.95
Gen III Analog	Nurse, TV	-	-	31012-004	\$86.95
	Nurse, TV, Pain Med, Bed Pan	-	-	31012-002	\$90.95
	Nurse, TV, 2 Lights	-	-	31012-003	\$90.95
	Nurse, TV, 2 Lights, Pain Med, Bed Pan	-	-	31012-001	\$94.95

NOTE: CALL for complete Pillow Speaker part numbers.

Part numbers are based on standard wiring and 8 ft. cable length. Call for additional options including ear jack, alternate cable length, and auxiliaries.

**PILLOW SPEAKER REPAIR**

DESCRIPTION	PRICE
Repair of Gen4 DirectAccess, Gen4 Digital, Gen4 Interactive, or Gen III Analog	CALL

**PILLOW SPEAKER TESTER**

DESCRIPTION	MODEL #	PART #	PRICE
Tester with one module	CT-300	6333	\$395.95
Additional module for this nurse call system	CALL	CALL	\$87.95

**PILLOW SPEAKER REPLACEMENT CABLES**

DESCRIPTION	LENGTH	MODEL #	PART #	PRICE
Replacement Cable for Gen4 Pillow Speaker	8'	CAD-3800	CALL	\$40.16
Replacement Cable for Gen III Pillow Speaker	8'	CA31012	CALL	\$44.95

**ADAPTORS** (see page 25 for descriptions of adaptor types)

TYPE	PLUG STYLE	RECEPTACLE 1	RECEPTACLE 2	RECEPTACLE 3	MODEL #	PART #	PRICE
Jumper	10-pin Modular	12-pin	-	-	JUP-1002-001	8488	\$25.95

**REPLACEMENT PILLOW SPEAKERS AND ACCESSORIES FOR:**

**Zettler®/SimplexGrinnell® Sentinel 400™**



**PILLOW SPEAKERS**

TYPE	FEATURES	DIGITAL VOLUME MODEL #	PRICE	ANALOG VOLUME MODEL #	PRICE
Gen4 DirectAccess	Nurse, TV, 0-9 Keypad	4C230-0-DV	\$97.95	4C230-0-AV	\$102.95
	Nurse, TV, 0-9 Keypad, 1 Light	4C230-1-DV	\$99.95	4C230-1-AV	\$104.95
	Nurse, TV, 0-9 Keypad, 2 Lights	4C230-2-DV	\$101.95	4C230-2-AV	\$106.95
Gen4 Digital	Nurse, TV	4D230-0-DV	\$88.95	4D230-0-AV	\$93.95
	Nurse, TV, 1 Light	4D230-1-DV	\$90.95	4D230-1-AV	\$95.95
	Nurse, TV, 2 Lights	4D230-2-DV	\$92.95	4D230-2-AV	\$97.95
Gen III Analog	Nurse, TV	-	-	3909-005	\$79.45
	Nurse, TV, 1 Light	-	-	3909-002	\$81.55
	Nurse, TV, 2 Lights	-	-	3909-006	\$83.65

NOTE: CALL for complete Pillow Speaker part numbers.

Part numbers are based on standard wiring and 8 ft. cable length. Call for additional options including ear jack, alternate cable length, and auxiliaries.

**PILLOW SPEAKER REPAIR**

DESCRIPTION	PRICE
Repair of Gen4 DirectAccess, Gen4 Digital, Gen4 Interactive, or Gen III Analog	CALL

**PILLOW SPEAKER TESTER**

DESCRIPTION	MODEL #	PART #	PRICE
Tester with one module	CT-300	6333	\$395.95
Additional module for this nurse call system	CALL	CALL	\$73.95

**PILLOW SPEAKER REPLACEMENT CABLES**

DESCRIPTION	LENGTH	MODEL #	PART #	PRICE
Replacement Cable for Gen4 Pillow Speaker	8'	CAD-2300	CALL	\$36.16
Replacement Cable for Gen III Pillow Speaker	8'	CA3909	CALL	\$38.95

**CALL CORDS** (1/4" accessories may require an adaptor)

DESCRIPTION	LENGTH	9-PIN D-SUB MODEL # (NORMALLY OPEN)	PART #	PRICE	1/4" PLUG MODEL #	PART #	PRICE
Gen4 Sealed Call Cord	8'	-	-	-	SCC-0101-080-N	13259	\$16.95
Gen4 Sealed Call Cord	12'	-	-	-	SCC-0101-120-N	13261	\$18.95
Classic Call Cord	8'	CC96-347	5854	\$30.95	CC96-010	5822	\$14.95
Classic Call Cord	12'	-	-	-	CC144-010	5733	\$16.95
BreathCall	9'	GEB-190	7393	\$169.95	GEB-010	7380	\$136.95
E-Z Call	10'	-	-	-	GEE-010	7402	\$64.95
Mechanical Pad	10'	GEM-160	7421	\$59.95	GEM-0000-AGY	7407	\$43.95
PadCall	8'	GEA-180	7368	\$70.95	GEA-030	7351	\$50.95
PressCall	8'	GEP-540	19436	\$72.95	GEP-140	7441	\$39.95

**ADAPTORS** (see page 25 for descriptions of adaptor types)

TYPE	PLUG STYLE	RECEPTACLE 1	RECEPTACLE 2	RECEPTACLE 3	MODEL #	PART #	PRICE
Box	9-pin D-Sub	9-pin D-Sub	1/4" jack (nurse call)	-	ADP-0909-102	3328	\$88.95
Box	9-pin D-Sub	9-pin D-Sub	1/4" jack (nurse call)	1/4" jack (TV)	ADP-0909-108	3333	\$98.95

**DUMMY PLUGS**

DESCRIPTION	MODEL #	PART #	PRICE
9-Pin, 6" Poly Cord	DP-160	6854	\$10.95

**REPLACEMENT PILLOW SPEAKERS AND ACCESSORIES FOR:**

**Zettler®/SimplexGrinnell® Sentinel 500™**



**PILLOW SPEAKERS**

TYPE	FEATURES	DIGITAL VOLUME MODEL #	PRICE	ANALOG VOLUME MODEL #	PRICE
Gen4 DirectAccess	Nurse, TV, 0-9 Keypad	4C235-0-DV	\$97.95	4C235-0-AV	\$102.95
	Nurse, TV, 0-9 Keypad, 1 Light	4C235-1-DV	\$99.95	4C235-1-AV	\$104.95
	Nurse, TV, 0-9 Keypad, 2 Lights	4C235-2-DV	\$101.95	4C235-2-AV	\$106.95
Gen4 Digital	Nurse, TV	4D235-0-DV	\$88.95	4D235-0-AV	\$93.95
	Nurse, TV, 1 Light	4D235-1-DV	\$90.95	4D235-1-AV	\$95.95
	Nurse, TV, 2 Lights	4D235-2-DV	\$92.95	4D235-2-AV	\$97.95
Gen III Analog	Nurse, TV	-	-	3909-312	\$79.45
	Nurse, TV, 1 Light	-	-	3909-314	\$81.55
	Nurse, TV, 2 Lights	-	-	3909-300	\$83.65

NOTE: CALL for complete Pillow Speaker part numbers.

Part numbers are based on standard wiring and 8 ft. cable length. Call for additional options including ear jack, alternate cable length, and auxiliaries.

**PILLOW SPEAKER REPAIR**

DESCRIPTION	PRICE
Repair of Gen4 DirectAccess, Gen4 Digital, Gen4 Interactive, or Gen III Analog	CALL

**PILLOW SPEAKER TESTER**

DESCRIPTION	MODEL #	PART #	PRICE
Tester with one module	CT-300	6333	\$395.95
Additional module for this nurse call system	CALL	CALL	\$73.95

**PILLOW SPEAKER REPLACEMENT CABLES**

DESCRIPTION	LENGTH	MODEL #	PART #	PRICE
Replacement Cable for Gen4 Pillow Speaker	8'	CAD-2300	CALL	\$36.16
Replacement Cable for Gen III Pillow Speaker	8'	CA3909	CALL	\$38.95

**CALL CORDS** (1/4" accessories may require an adaptor)

DESCRIPTION	LENGTH	9-PIN D-SUB MODEL # (NORMALLY CLOSED)	PART #	PRICE	1/4" PLUG MODEL # (NORMALLY CLOSED)	PART #	PRICE
Classic Call Cord	8'	CC96-740	5859	\$30.95	CC96-320	5853	\$14.95
BreathCall	9'	GEB-195	7394	\$169.95	GEB-025	7382	\$136.95
E-Z Call	10'	-	-	-	GEE-090	7403	\$64.95
PadCall	8'	GEA-195	7371	\$88.95	GEA-080	7355	\$51.95
PressCall	8'	GEP-500	7462	\$75.95	GEP-045	7436	\$46.95

**ADAPTORS**(see page 25 for descriptions of adaptor types)

TYPE	PLUG STYLE	RECEPTACLE 1	RECEPTACLE 2	RECEPTACLE 3	MODEL #	PART #	PRICE
Box	9-pin D-Sub	9-pin D-Sub	1/4" jack (nurse call)	-	ADP-0909-103	3329	\$88.95
Box	9-pin D-Sub	9-pin D-Sub	1/4" jack (nurse call)	1/4" jack (TV)	ADP-0909-105	3330	\$98.95

**DUMMY PLUGS**

DESCRIPTION	MODEL #	PART #	PRICE
9-Pin, 6" Poly Cord	DP-165	6855	\$10.95

**REPLACEMENT PILLOW SPEAKERS AND ACCESSORIES FOR:**

**Zenith (TV Control Only)**

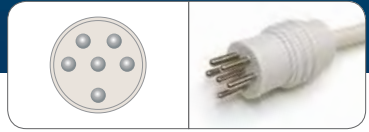

**PILLOW SPEAKERS**

TYPE	FEATURES	DIGITAL VOLUME MODEL #	PRICE	ANALOG VOLUME MODEL #	PRICE
Gen4 DirectAccess	TV, 0-9 Keypad	4C020-0-DV	\$88.95	4C020-0-AV	\$93.95
	TV, 0-9 Keypad, 1 Light	4C020-1-DV	\$90.95	4C020-1-AV	\$95.95
	TV*	4D020-0-DV	\$72.95	4D020-0-AV	\$77.95
Gen III Analog	TV, 1 Light	4D020-1-DV	\$74.95	4D020-1-AV	\$79.95
	TV	-	-	3106-001	\$60.55
	TV, Channel Up/Dn (Hard-Wired)	-	-	3106-034	\$64.75

NOTE: CALL for complete Pillow Speaker part numbers.

Part numbers are based on standard wiring and 8 ft. cable length. Call for additional options including ear jack, alternate cable length, and auxiliaries.

**PILLOW SPEAKER REPAIR**

DESCRIPTION	PRICE
Repair of Gen4 DirectAccess, Gen4 Digital, Gen4 Interactive, or Gen III Analog	CALL

**PILLOW SPEAKER TESTER**

DESCRIPTION	MODEL #	PART #	PRICE
Tester with one module	CT-300	6333	\$395.95
Additional module for this nurse call system	CALL	CALL	\$79.95

**PILLOW SPEAKER REPLACEMENT CABLES**

DESCRIPTION	LENGTH	MODEL #	PART #	PRICE
Replacement Cable for Gen4 Pillow Speaker	8'	CAD-0200	CALL	\$20.95
Replacement Cable for Gen III Pillow Speaker	8'	CA3106	CALL	\$22.95

**REPLACEMENT PILLOW SPEAKERS AND ACCESSORIES FOR:**

**RCA® (TV Control Only)**



**PILLOW SPEAKERS**

TYPE	FEATURES	ANALOG VOLUME MODEL #	PRICE
Gen III Analog	TV Only	3205-001	\$61.60

NOTE: CALL for complete Pillow Speaker part numbers.

Part numbers are based on standard wiring and 8 ft. cable length. Call for additional options including ear jack, alternate cable length, and auxiliaries.

**PILLOW SPEAKER REPAIR**

DESCRIPTION	PRICE
Repair of Gen III Analog	CALL

**PILLOW SPEAKER REPLACEMENT CABLES**

DESCRIPTION	LENGTH	MODEL #	PART #	PRICE
Replacement Cable for Gen4 Pillow Speaker	8'	CA3205	CALL	\$26.95



**REPLACEMENT PILLOW SPEAKERS AND ACCESSORIES FOR:**

**Applications Without Nurse Call**



**PILLOW SPEAKERS**

TYPE	FEATURES	DIGITAL VOLUME MODEL #	PRICE	ANALOG VOLUME MODEL #	PRICE
Gen4 DirectAccess	TV, 0-9 Keypad	4C010-0-DV	\$84.95	4C010-0-AV	\$89.95
Gen4 Digital	TV	4D010-0-DV	\$69.95	4D010-0-AV	\$74.95
Gen III Analog	TV	-	-	3103-001	\$52.15

NOTE: CALL for complete Pillow Speaker part numbers.

Part numbers are based on standard wiring and 8 ft. cable length. Call for additional options including ear jack, alternate cable length, and auxiliaries.

**PILLOW SPEAKER REPAIR**

DESCRIPTION	PRICE
Repair of Gen4 DirectAccess, Gen4 Digital, Gen4 Interactive, or Gen III Analog	CALL

**PILLOW SPEAKER TESTER**

DESCRIPTION	MODEL #	PART #	PRICE
Tester with one module	CT-300	6333	\$395.95
Additional module for this nurse call system	CALL	CALL	\$73.95

**PILLOW SPEAKER REPLACEMENT CABLES**

DESCRIPTION	LENGTH	MODEL #	PART #	PRICE
Replacement Cable for Gen4 Pillow Speaker	8'	CAD-0100	CALL	\$18.16
Replacement Cable for Gen III Pillow Speaker	8'	CA3103	CALL	\$20.95

**REPLACEMENT PILLOW SPEAKERS AND ACCESSORIES FOR:**

**Universal Centronics Breakaway Applications**

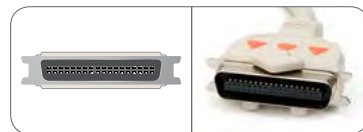

**PILLOW SPEAKERS**

TYPE	FEATURES	DIGITAL VOLUME MODEL #	PRICE	ANALOG VOLUME MODEL #	PRICE
Gen4 DirectAccess	Nurse, TV, 0-9 Keypad	4C350-0-DV	\$98.95	4C350-0-AV	\$103.95
	Nurse, TV, 0-9 Keypad, 1 Light	4C350-1-DV	\$100.95	4C350-1-AV	\$105.95
	Nurse, TV, 0-9 Keypad, 2 Lights	4C350-2-DV	\$102.95	4C350-2-AV	\$107.95
Gen4 Digital	Nurse, TV	4D350-0-DV	\$92.95	4D350-0-AV	\$97.95
	Nurse, TV, 1 Light	4D350-1-DV	\$94.95	4D350-2-AV	\$99.95
	Nurse, TV, 2 Lights	4D350-2-DV	\$96.95	4D350-2-AV	\$101.95
Gen III Analog	Nurse, TV, Room Light, Read Light	-	-	33601-301	\$106.75

NOTE: CALL for complete Pillow Speaker part numbers.

Part numbers are based on standard wiring and 8 ft. cable length. Call for additional options including ear jack, alternate cable length, and auxiliaries.

**PILLOW SPEAKER REPAIR**

DESCRIPTION	PRICE
Repair of Gen4 DirectAccess, Gen4 Digital, Gen4 Interactive, or Gen III Analog	CALL

**PILLOW SPEAKER TESTER**

DESCRIPTION	MODEL #	PART #	PRICE
Tester with one module	CT-300	6333	\$395.95
Additional module for this nurse call system	CALL	CALL	\$95.95

**PILLOW SPEAKER REPLACEMENT CABLES**

DESCRIPTION	LENGTH	MODEL #	PART #	PRICE
Replacement Cable for Gen4 Pillow Speaker	8'	CAD-3500	CALL	\$52.16
Replacement Cable for Gen III Pillow Speaker	8'	CA33601	CALL	\$62.95

**PILLOW SPEAKER PARTS**

**GEN4 PILLOW SPEAKERS**

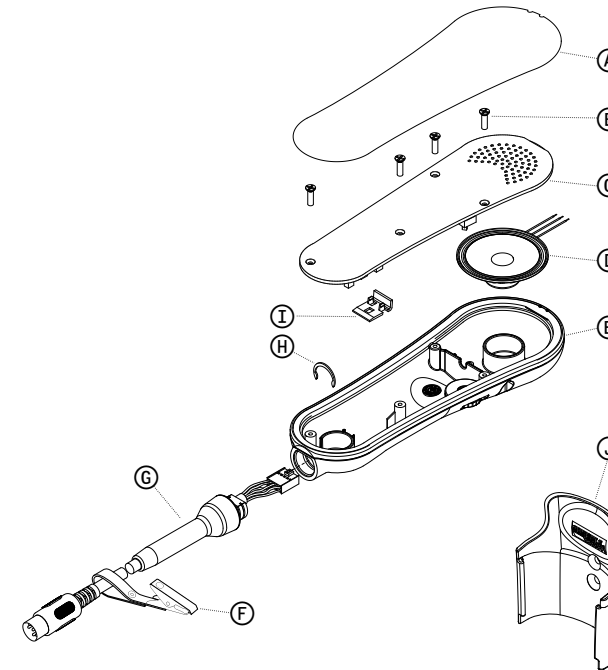

DIAGRAM	MODEL #	PART #	DESCRIPTION	PRICE
A	OLY-G4D	Call	Overlay for Gen4 Digital and DirectAccess	Call
A	OLY-G4I	Call	Overlay for Gen4 Interactive	Call
B	HDW-1018-001	7490	Case/Board Screws	\$0.10
C	K4D-PCB	Call	PC Board kit for DPS, Configured (Speaker, Overlay, Switches, Optional Volume Control)	Call
C	K4C-PCB	Call	PC Board kit for DirectAccess, Configured (Speaker, Overlay, Switches, Optional Volume Control)	Call
D	SPR-1000-600	13624	Speaker, 40 Ohm	\$8.95
E	CBK-4000-001	5603	Case for Units with Digital Volume Control	\$7.05
E	CBK-4000-003	5604	Case for Units with Digital Volume Control and Headphone Option	\$7.05
E	CBK-4000-A02	5607	Case for Units with Analog Volume Control	\$8.05
E	CBK-4000-A04	5608	Case for Units with Analog Volume Control and Headphone Option	\$8.05
F	FA-135	7333	Linen Clip, locking snap	\$1.25
G	CAD-G4-8	Call	Replacement Cable, Configured, Strain	Call
H	MSC-1028-010	9556	C Clips, Bag of 10	\$1.95
I	MSC-4020-002	9595	Header Lock, 10-Pin	\$0.50
I	MSC-4020-003	9596	Header Lock, 24-Pin	\$0.50
J	MSC-4023-001	9598	Pillow Speaker Holder	\$8.95

**GEN III PILLOW SPEAKERS**

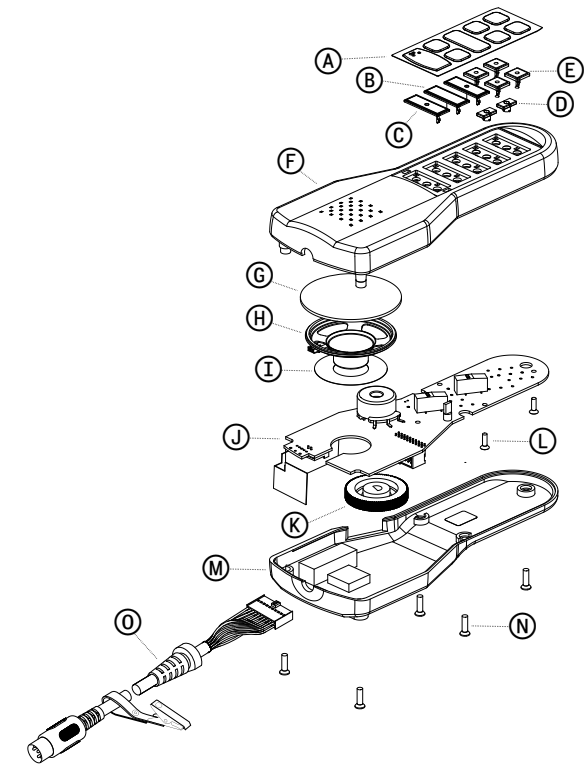

DIAGRAM	MODEL #	PART #	DESCRIPTION	PRICE
A	Various	Call	Overlay	Call
B	AB-040	3209	Large Blank	\$0.40
C	AB-030	3206	Large Actuator	\$0.40
D	MS-395	9475	Spacer	\$0.40
E	AB-020	3201	Small Actuator	\$0.40
F	CF-1000	5960	Case Front	\$6.25
G	MS-090	9413	Foam Disk	\$0.20
H	SP-015	13619	Speaker - 3.2 Ohm	\$7.50
H	SP-032	13620	Speaker - 8 Ohm	\$7.50
H	SP-075	13622	Speaker - 40 Ohm	\$7.50
I	MS-155	9427	Speaker Insulator	\$0.30
J	Various	Call	Circuit Board Assembly (PCB, Potentiometer, Switches)	Call
K	KB-050	8520	Volume Knob	\$1.25
L	HW-370	7621	Circuit Board Screws	\$0.15
M	CB-1000	5455	Case Back	\$5.95
N	HW-380	7622	Case Screws	\$0.15
O	Various	Call	Cable	Call



CALL CURBELL  
TOLL-FREE AT  
**1-800-235-7500**

## OTHER PRODUCT LINES



### PATIENT MONITORING

- ▣ Reusable ECG Cables
- ▣ Reusable ECG Lead Wires
- ▣ Disposable ECG Lead Wires
- ▣ SPO<sub>2</sub> Probes
- ▣ Cable Management

### FALL MANAGEMENT

- ▣ Chair and Bed Sensors
- ▣ Sensor Pads
- ▣ Seat Belt Sensors
- ▣ Floor Mat Sensors
- ▣ Floor Cushions and Sensors

## ORDERING AND WARRANTY INFORMATION

### PLACING ORDERS

Orders may be subject to a minimum order requirement. Part numbers, product availability, and pricing are subject to change without notice.

### VIA PHONE

Call Curbell toll-free anywhere in the US or Canada at 1-800-235-7500. Outside of the US, call 1-716-667-2520.

### VIA FAX

Fax us at 716-667-7775

### E-MAIL

We want to hear from you. Contact us with your comments and suggestions at [info@curbellmedical.com](mailto:info@curbellmedical.com)

### PAYMENT TERMS

- ▣ Net 30 days terms are extended to established accounts
- ▣ Payment with order: send check or money order. Please call our toll-free number for the exact shipping charge
- ▣ COD: Pay the full amount including shipping upon receipt
- ▣ Visa, MasterCard, Discover, and American Express are gladly accepted
- ▣ Shipping and handling charges will be added to every order

### SELLER'S LIMITED WARRANTY

Unless otherwise stated in the limited warranty contained in literature that is shipped with the product (in which case the product literature limited warranty will in all respects apply), the Seller warrants the Buyer that the products will be free from defects in workmanship and materials under normal use for the period of two years from the date of the applicable invoice for pillow speakers and a period of one year from the date of the applicable invoice for all other products and repair services. Repair of pillow speakers is under a 90-day limited warranty against defects in materials and workmanship.

### HOW TO RETURN MERCHANDISE

All returns must be processed within 60 days of delivery date and are subject to a 25% restocking fee. Product must be in new, resalable condition, and in the original packaging. Custom-made items are non-returnable. Contact Customer Service at 1-800-235-7500 and ask for a return merchandise authorization number (RMA#). Enclose this RMA# with the item, print the RMA# on the outside of the package, and mail it to:

Curbell Medical Products, Inc.  
20 Centre Drive  
Orchard Park, NY 14127



Commercial Solutions, Inc.  
5511 W. 79th Street  
Indianapolis, IN 46268  
1-877-767-4002  
[sales@csi-tv.net](mailto:sales@csi-tv.net)



Call Us  
**1-877-767-4002**

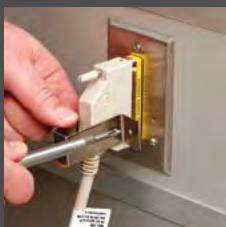

Hospital patient rooms depend on connectivity — between patients and nurses, and the various technologies that impact the patient experience.

Curbell Medical is a crucial part of the ever-evolving interface that makes all of these connections possible. By combining our deep institutional knowledge and decades of experience, we create innovative solutions that make hospitals more efficient, and improve patient comfort and safety. It's instant peace of mind, and it's as easy as pressing a button.